

TLC0831C, TLC0831I
TLC0832C, TLC0832I

8-BIT ANALOG-TO-DIGITAL CONVERTERS WITH SERIAL CONTROL

SLAS107B – JANUARY 1995 – REVISED APRIL 1996

- **8-Bit Resolution**
- **Easy Microprocessor Interface or Standalone Operation**
- **Operates Ratiometrically or With 5-V Reference**
- **Single Channel or Multiplexed Twin Channels With Single-Ended or Differential Input Options**
- **Input Range 0 to 5 V With Single 5-V Supply**
- **Inputs and Outputs Are Compatible With TTL and MOS**
- **Conversion Time of 32 μ s at $f_{\text{clock}} = 250$ kHz**
- **Designed to Be Interchangeable With National Semiconductor ADC0831 and ADC0832**
- **Total Unadjusted Error . . . ± 1 LSB**

TLC0831 . . . D OR P PACKAGE
(TOP VIEW)

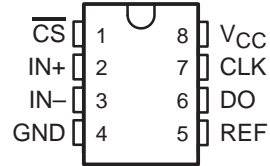

TLC0832 . . . D OR P PACKAGE
(TOP VIEW)

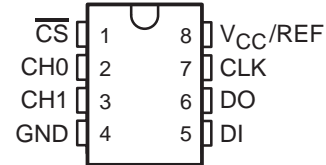

description

These devices are 8-bit successive-approximation analog-to-digital converters. The TLC0831 has single input channels; the TLC0832 has multiplexed twin input channels. The serial output is configured to interface with standard shift registers or microprocessors.

The TLC0832 multiplexer is software configured for single-ended or differential inputs. The differential analog voltage input allows for common-mode rejection or offset of the analog zero input voltage value. In addition, the voltage reference input can be adjusted to allow encoding any smaller analog voltage span to the full 8 bits of resolution.

The operation of the TLC0831 and TLC0832 devices is very similar to the more complex TLC0834 and TLC0838 devices. Ratiometric conversion can be attained by setting the REF input equal to the maximum analog input signal value, which gives the highest possible conversion resolution. Typically, REF is set equal to V_{CC} (done internally on the TLC0832).

The TLC0831C and TLC0832C are characterized for operation from 0°C to 70°C. The TLC0831I and TLC0832I are characterized for operation from -40°C to 85°C.

AVAILABLE OPTIONS

T _A	PACKAGE			
	SMALL OUTLINE (D)		PLASTIC DIP (P)	
0°C to 70°C	TLC0831CD	TLC0832CD	TLC0831CP	TLC0832CP
-40°C to 85°C	TLC0831ID	TLC0832ID	TLC0831IP	TLC0832IP



Please be aware that an important notice concerning availability, standard warranty, and use in critical applications of Texas Instruments semiconductor products and disclaimers thereto appears at the end of this data sheet.

PRODUCTION DATA information is current as of publication date. Products conform to specifications per the terms of Texas Instruments standard warranty. Production processing does not necessarily include testing of all parameters.

**TEXAS
INSTRUMENTS**

POST OFFICE BOX 655303 • DALLAS, TEXAS 75265

Copyright © 1996, Texas Instruments Incorporated

TLC0831C, TLC0831I
 TLC0832C, TLC0832I
8-BIT ANALOG-TO-DIGITAL CONVERTERS WITH SERIAL CONTROL
 SLAS107B – JANUARY 1995 – REVISED APRIL 1996

functional block diagram

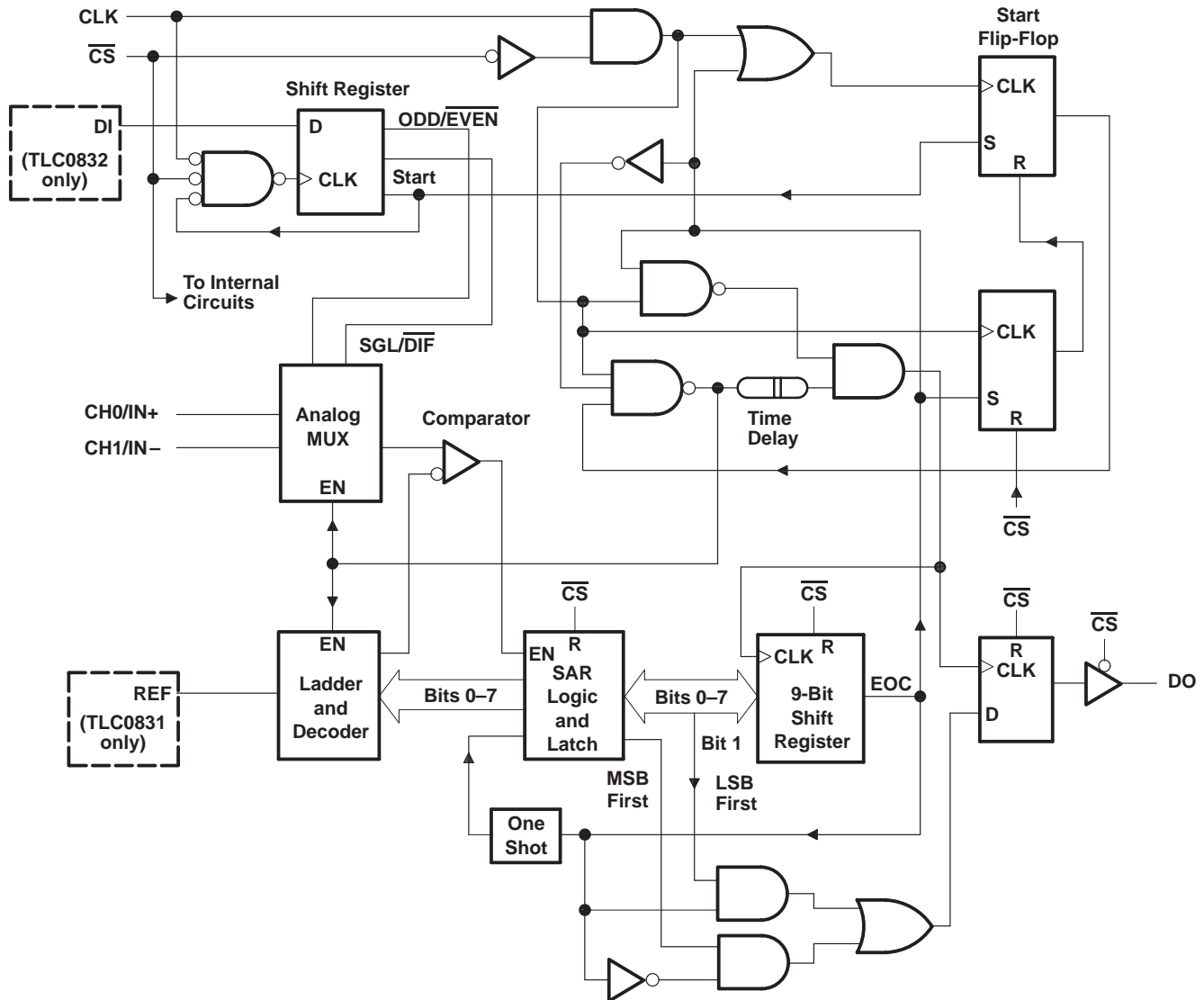

functional description

The TLC0831 and TLC0832 use a sample-data-comparator structure that converts differential analog inputs by a successive-approximation routine. The input voltage to be converted is applied to an input terminal and is compared to ground (single ended), or to an adjacent input (differential). The TLC0832 input terminals can be assigned a positive (+) or negative (–) polarity. The TLC0831 contains only one differential input channel with fixed polarity assignment; therefore it does not require addressing. The signal can be applied differentially, between IN+ and IN–, to the TLC0831 or can be applied to IN+ with IN– grounded as a single ended input. When the signal input applied to the assigned positive terminal is less than the signal on the negative terminal, the converter output is all zeros.

Channel selection and input configuration are under software control using a serial-data link from the controlling processor. A serial-communication format allows more functions to be included in a converter package with no increase in size. In addition, it eliminates the transmission of low-level analog signals by locating the converter at the analog sensor and communicating serially with the controlling processor. This process returns noise-free digital data to the processor.

A conversion is initiated by setting \overline{CS} low, which enables all logic circuits. \overline{CS} must be held low for the complete conversion process. A clock input is then received from the processor. An interval of one clock period is automatically inserted to allow the selected multiplexed channel to settle. DO comes out of the high-impedance state and provides a leading low for one clock period of multiplexer settling time. The SAR comparator compares successive outputs from the resistive ladder with the incoming analog signal. The comparator output indicates whether the analog input is greater than or less than the resistive-ladder output. As the conversion proceeds, conversion data is simultaneously output from DO, with the most significant bit (MSB) first. After eight clock periods, the conversion is complete. When \overline{CS} goes high, all internal registers are cleared. At this time, the output circuits go to the high-impedance state. If another conversion is desired, \overline{CS} must make a high-to-low transition followed by address information.

A TLC0832 input configuration is assigned during the multiplexer-addressing sequence. The multiplexer address shifts into the converter through the data input (DI) line. The multiplexer address selects the analog inputs to be enabled and determines whether the input is single ended or differential. When the input is differential, the polarity of the channel input is assigned. In addition to selecting the differential mode, the polarity may also be selected. Either channel of the channel pair may be designated as the negative or positive input.

On each low-to-high transition of the clock input, the data on DI is clocked into the multiplexer-address shift register. The first logic high on the input is the start bit. A 2-bit assignment word follows the start bit on the TLC0832. On each successive low-to-high transition of the clock input, the start bit and assignment word are shifted through the shift register. When the start bit is shifted into the start location of the multiplexer register, the input channel is selected and conversion starts. The TLC0832 DI terminal to the multiplexer shift register is disabled for the duration of the conversion.

The TLC0832 outputs the least-significant-bit (LSB) first data after the MSB-first data stream. The DI and DO terminals can be tied together and controlled by a bidirectional processor I/O bit received on a single wire. This is possible because DI is only examined during the multiplexer-addressing interval and DO is still in the high-impedance state.

TLC0831C, TLC0831I
 TLC0832C, TLC0832I
8-BIT ANALOG-TO-DIGITAL CONVERTERS WITH SERIAL CONTROL
 SLAS107B – JANUARY 1995 – REVISED APRIL 1996

sequence of operation

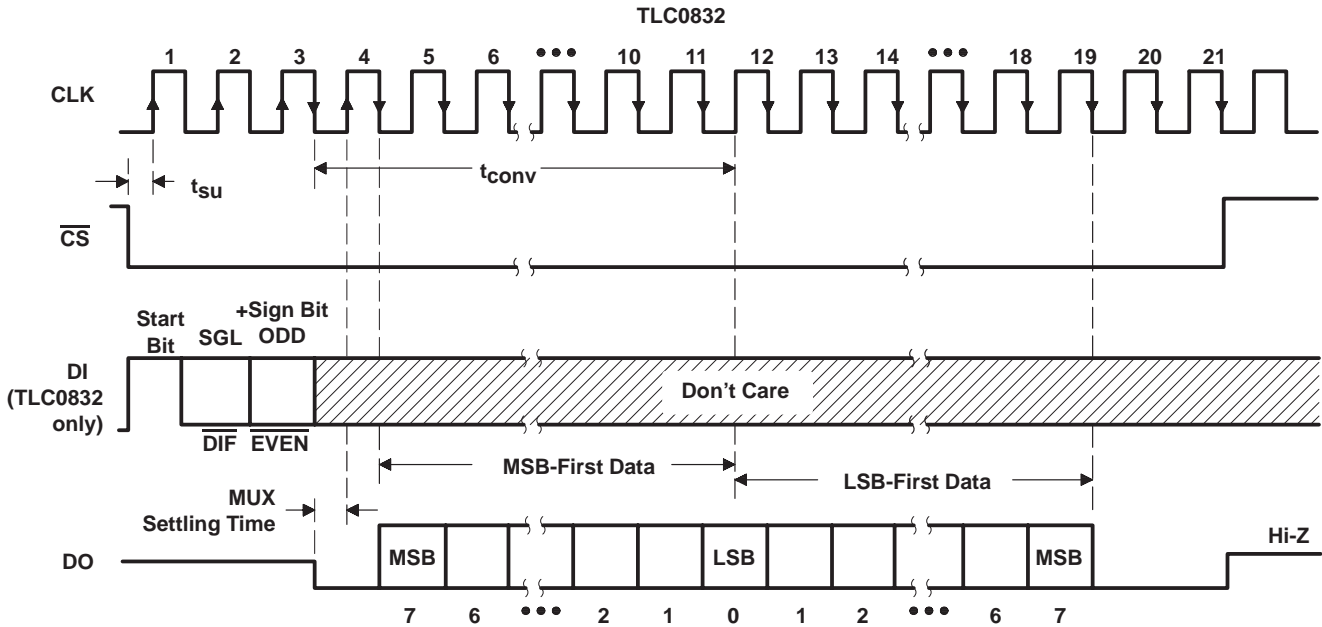
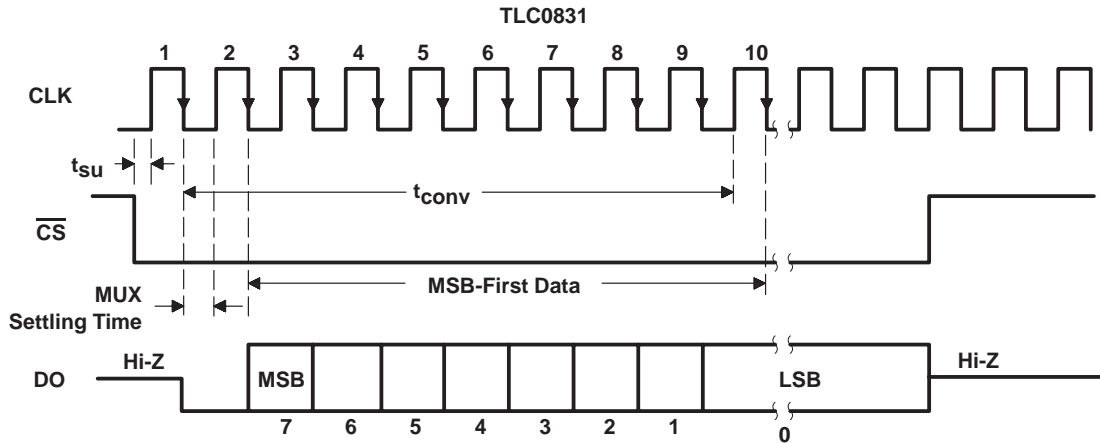

TLC0832 MUX-ADDRESS CONTROL LOGIC TABLE

MUX ADDRESS		CHANNEL NUMBER	
SGL/DIF	ODD/EVEN	CH0	CH1
L	L	+	-
L	H	-	+
H	L	+	
H	H		+

H = high level, L = low level,
 - or + = terminal polarity for the selected input channel

8-BIT ANALOG-TO-DIGITAL CONVERTERS WITH SERIAL CONTROL

SLAS107B – JANUARY 1995 – REVISED APRIL 1996

absolute maximum ratings over recommended operating free-air temperature range (unless otherwise noted)†

Supply voltage, V_{CC} (see Note 1)	6.5 V
Input voltage range, V_I : Logic	-0.3 V to $V_{CC} + 0.3$ V
Analog	-0.3 V to $V_{CC} + 0.3$ V
Input current, I_I	± 5 mA
Total input current	± 20 mA
Operating free-air temperature range, T_A : C suffix	0°C to 70°C
I suffix	-40°C to 85°C
Storage temperature range, T_{stg}	-65°C to 150°C
Lead temperature 1,6 mm (1/16 inch) from case for 10 seconds: P package	260°C

† Stresses beyond those listed under "absolute maximum ratings" may cause permanent damage to the device. These are stress ratings only, and functional operation of the device at these or any other conditions beyond those indicated under "recommended operating conditions" is not implied. Exposure to absolute-maximum-rated conditions for extended periods may affect device reliability.

NOTE 1: All voltage values, except differential voltages, are with respect to the network ground terminal.

recommended operating conditions

	MIN	NOM	MAX	UNIT
Supply voltage, V_{CC}	4.5	5	5.5	V
High-level input voltage, V_{IH}	2			V
Low-level input voltage, V_{IL}			0.8	V
Clock frequency, f_{clock}	10		600	kHz
Clock duty cycle (see Note 2)	40%		60%	
Pulse duration, \overline{CS} high, $t_{wH}(CS)$	220			ns
Setup time, \overline{CS} low or TLC0832 data valid before $CLK\uparrow$, t_{su}	350			ns
Hold time, TLC0832 data valid after $CLK\uparrow$, t_h	90			ns
Operating free-air temperature, T_A	C suffix		70	°C
	I suffix	-40	85	

NOTE 2: The clock-duty-cycle range ensures proper operation at all clock frequencies. When a clock frequency is used outside the recommended duty-cycle range, the minimum pulse duration (high or low) is 1 μ s.

TLC0831C, TLC0831I
TLC0832C, TLC0832I

8-BIT ANALOG-TO-DIGITAL CONVERTERS WITH SERIAL CONTROL

SLAS107B – JANUARY 1995 – REVISED APRIL 1996

electrical characteristics over recommended range of operating free-air temperature, $V_{CC} = 5\text{ V}$, $f_{\text{clock}} = 250\text{ kHz}$ (unless otherwise noted)

digital section

PARAMETER	TEST CONDITION [†]	C SUFFIX			I SUFFIX			UNIT
		MIN	TYP [‡]	MAX	MIN	TYP [‡]	MAX	
V _{OH} High-level output voltage	V _{CC} = 4.75 V, I _{OH} = -360 μA	2.8			2.4			V
	V _{CC} = 4.75 V, I _{OH} = -10 μA	4.6			4.5			
V _{OL} Low-level output voltage	V _{CC} = 4.75 V, I _{OL} = 1.6 mA	0.34			0.4			V
I _{IH} High-level input current	V _{IH} = 5 V		0.005	1		0.005	1	μA
I _{IL} Low-level input current	V _{IL} = 0		-0.005	-1		-0.005	-1	μA
I _{OH} High-level output (source) current	V _{OH} = V _O , T _A = 25°C	-6.5	-24		-6.5	-24		mA
I _{OL} Low-level output (sink) current	V _{OL} = V _{CC} , T _A = 25°C	8	26		8	26		mA
I _{OZ} High-impedance-state output current (DO)	V _O = 5 V, T _A = 25°C		0.01	3		0.01	3	μA
	V _O = 0, T _A = 25°C		-0.01	-3		-0.01	-3	
C _i Input capacitance			5			5		pF
C _o Output capacitance			5			5		pF

[†] All parameters are measured under open-loop conditions with zero common-mode input voltage.

[‡] All typical values are at V_{CC} = 5 V, T_A = 25°C.

analog and converter section

PARAMETER	TEST CONDITION [†]	MIN	TYP [‡]	MAX	UNIT
V _{IC} Common-mode input voltage	See Note 3	-0.05 to V _{CC} +0.05			V
I _{I(stb)} Standby input current (see Note 4)	On channel	V _I = 5 V		1	μA
	Off channel	V _I = 0		-1	
	On channel	V _I = 0		-1	
	Off channel	V _I = 5 V		1	
r _{i(REF)} Input resistance to REF		1.3	2.4	5.9	kΩ

[†] All parameters are measured under open-loop conditions with zero common-mode input voltage.

[‡] All typical values are at V_{CC} = 5 V, T_A = 25°C.

NOTES: 3. When channel IN- is more positive than channel IN+, the digital output code is 0000 0000. Connected to each analog input are two on-chip diodes that conduct forward current for analog input voltages one diode drop above V_{CC}. Care must be taken during testing at low V_{CC} levels (4.5 V) because high-level analog input voltage (5 V) can, especially at high temperatures, cause the input diode to conduct and cause errors for analog inputs that are near full scale. As long as the analog voltage does not exceed the supply voltage by more than 50 mV, the output code is correct. To achieve an absolute 0- to 5-V input range requires a minimum V_{CC} of 4.95 V for all variations of temperature and load.

4. Standby input currents go in or out of the on or off channels when the A/D converter is not performing conversion and the clock is in a high or low steady-state conditions.

total device

PARAMETER	MIN	TYP [‡]	MAX	UNIT
I _{CC} Supply current	TLC0831	0.6	1.25	mA
	TLC0832	2.5	4.7	

[‡] All typical values are at V_{CC} = 5 V, T_A = 25°C.



8-BIT ANALOG-TO-DIGITAL CONVERTERS WITH SERIAL CONTROL

SLAS107B – JANUARY 1995 – REVISED APRIL 1996

operating characteristics $V_{CC} = V_{ref} = 5\text{ V}$, $f_{clock} = 250\text{ kHz}$, $t_r = t_f = 20\text{ ns}$, $T_A = 25^\circ\text{C}$ (unless otherwise noted)

PARAMETER		TEST CONDITIONS†	MIN	TYP	MAX	UNIT
Supply-voltage variation error		$V_{CC} = 4.75\text{ V to }5.25\text{ V}$		$\pm 1/16$	$\pm 1/4$	LSB
Total unadjusted error (see Note 5)		$V_{ref} = 5\text{ V}$, $T_A = \text{MIN to MAX}$			± 1	LSB
Common-mode error		Differential mode		$\pm 1/16$	$\pm 1/4$	LSB
t_{pd}	Propagation delay time, output data after $\text{CLK}\uparrow$ (see Note 6)	MSB-first data	$C_L = 100\text{ pF}$	650	1500	ns
		LSB-first data		250	600	
t_{dis}	Output disable time, DO after $\overline{\text{CS}}\uparrow$	$C_L = 10\text{ pF}$, $R_L = 10\text{ k}\Omega$		125	250	ns
		$C_L = 100\text{ pF}$, $R_L = 2\text{ k}\Omega$			500	
t_{conv}	Conversion time (multiplexer-addressing time not included)				8	clock periods

† All parameters are measured under open-loop conditions with zero common-mode input voltage. For conditions shown as MIN or MAX, use the appropriate value specified under recommended operating conditions.

- NOTES: 5. Total unadjusted error includes offset, full-scale, linearity, and multiplexer errors.
6. The MSB-first data is output directly from the comparator and, therefore, requires additional delay to allow for comparator response time. LSB-first data applies only to TLC0832.

PARAMETER MEASUREMENT INFORMATION

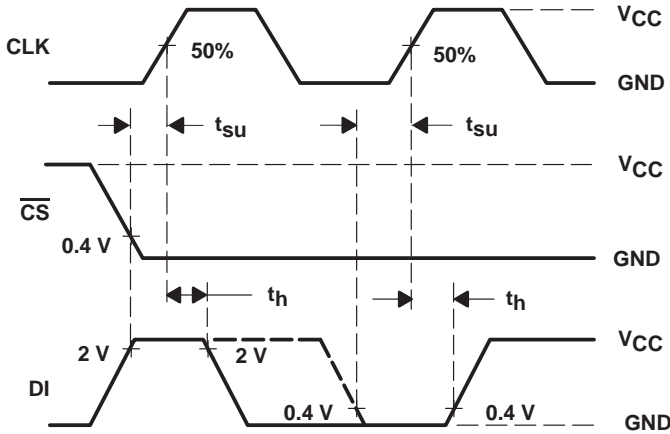

Figure 1. TLC0832 Data-Input Timing

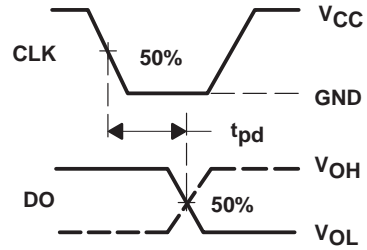
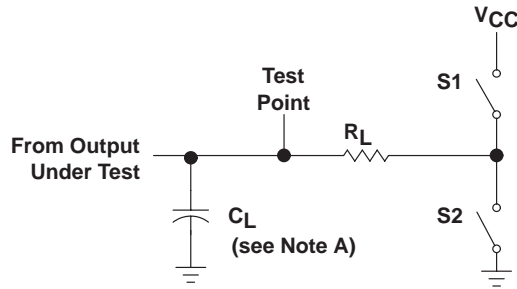
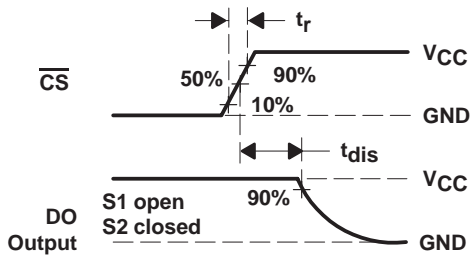

Figure 2. Data-Output Timing



LOAD CIRCUIT



VOLTAGE WAVEFORMS

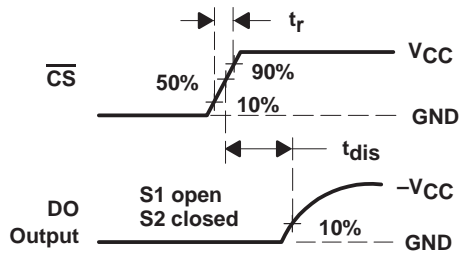

VOLTAGE WAVEFORMS

NOTE A: C_L includes probe and jig capacitance.

Figure 3. Output Disable Time Test Circuit and Voltage Waveforms

TYPICAL CHARACTERISTICS

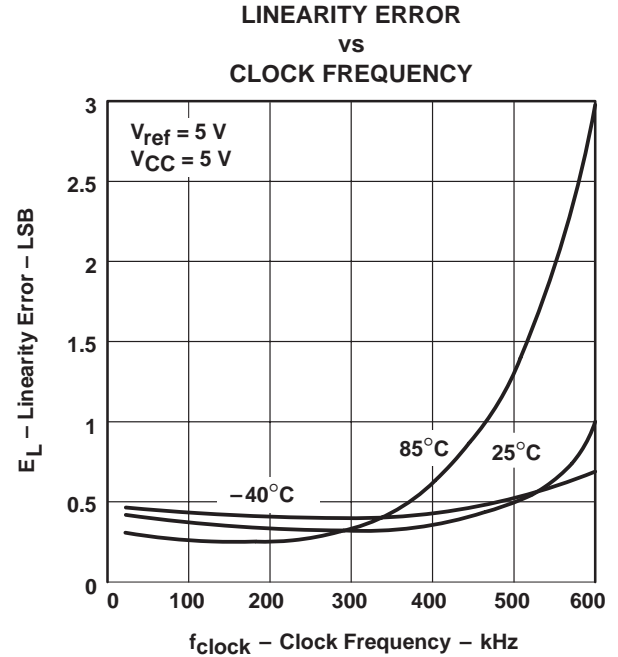
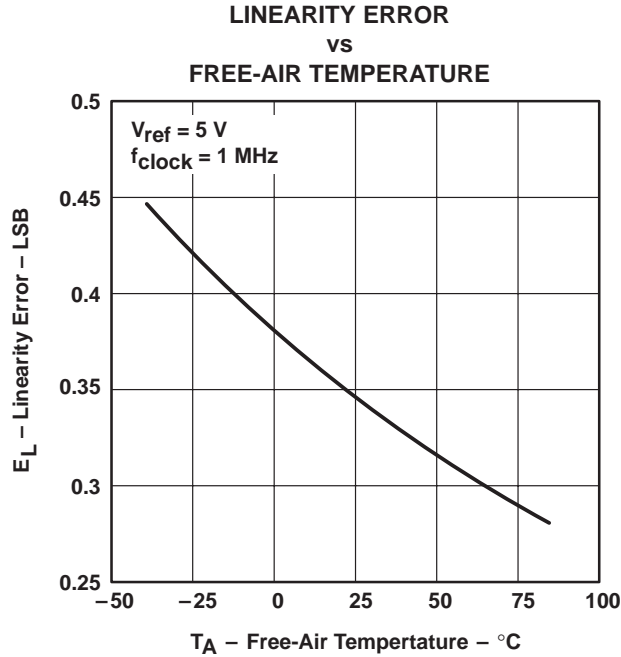
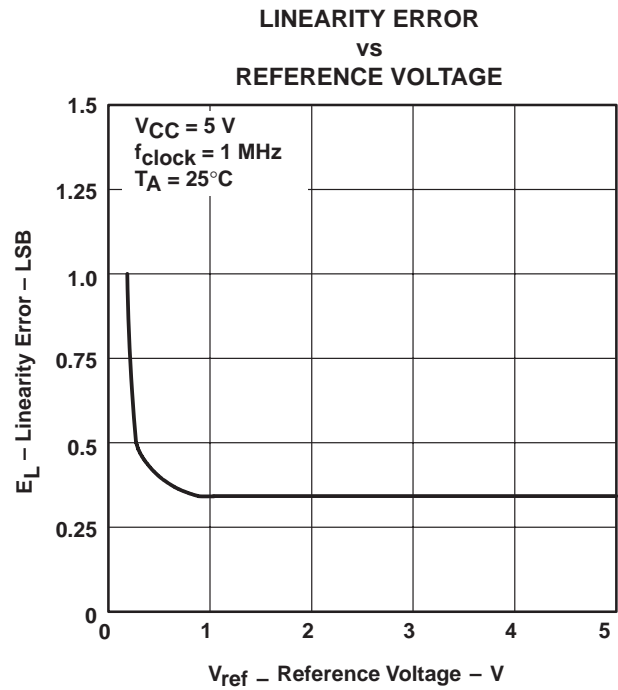
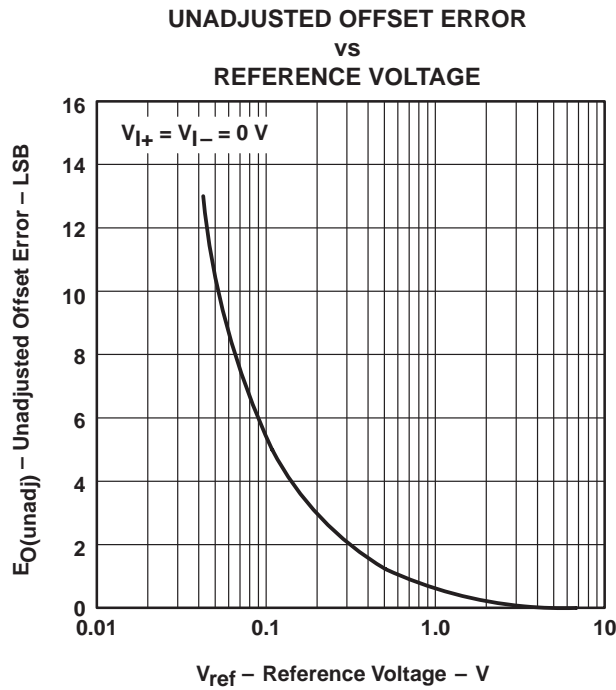

TYPICAL CHARACTERISTICS

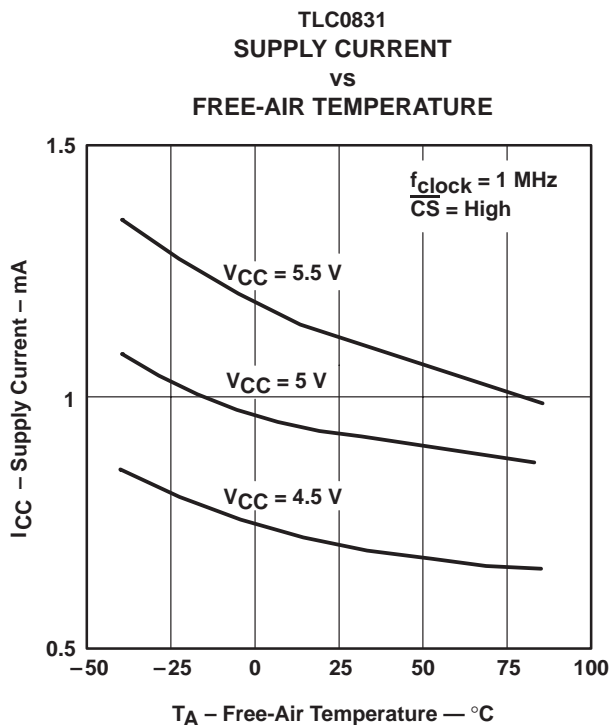

Figure 8

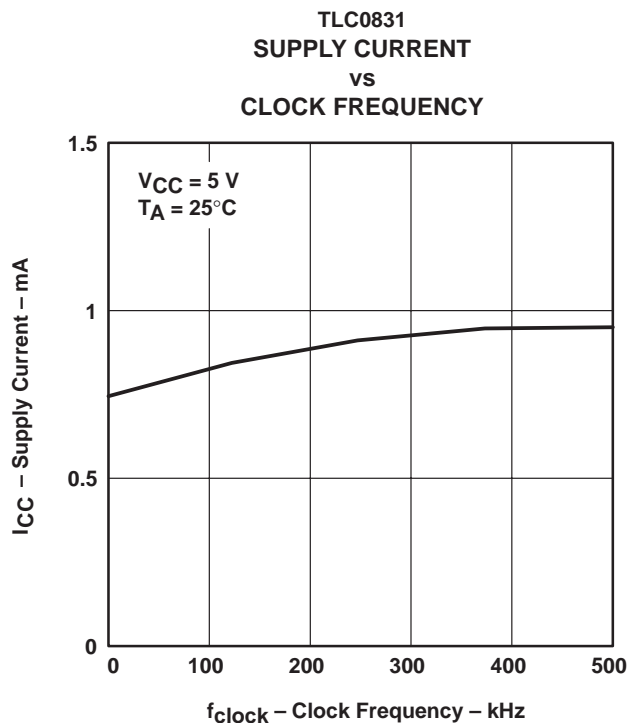

Figure 9

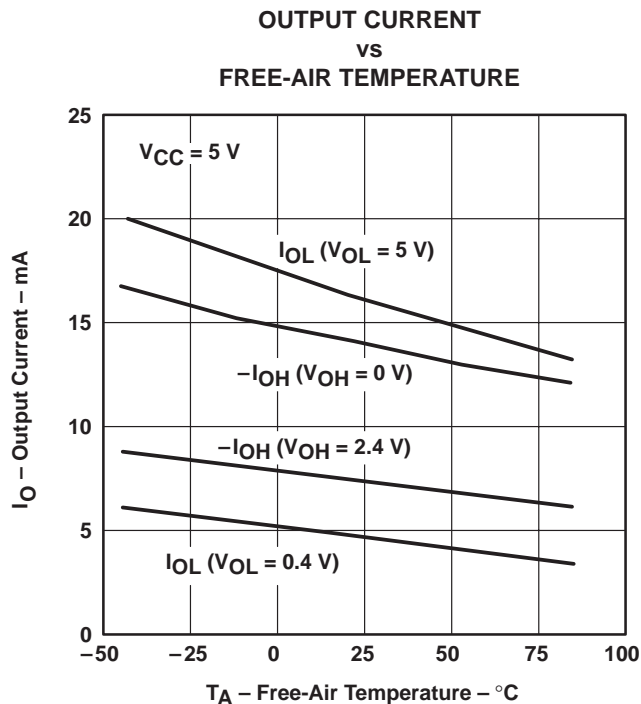

Figure 10

TYPICAL CHARACTERISTICS

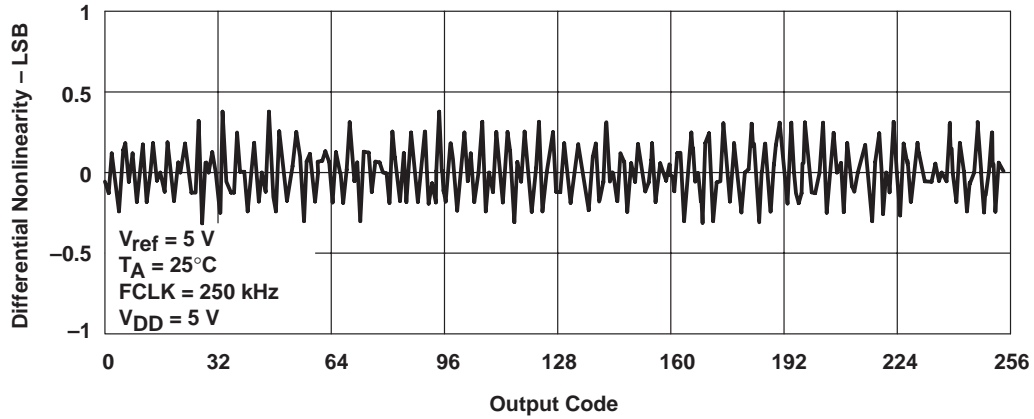

Figure 11. Differential Nonlinearity With Output Code

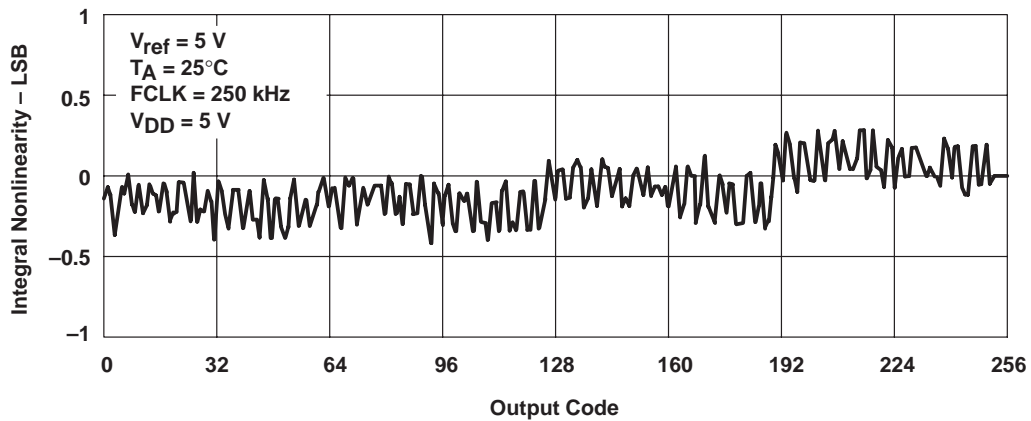

Figure 12. Integral Nonlinearity With Output Code

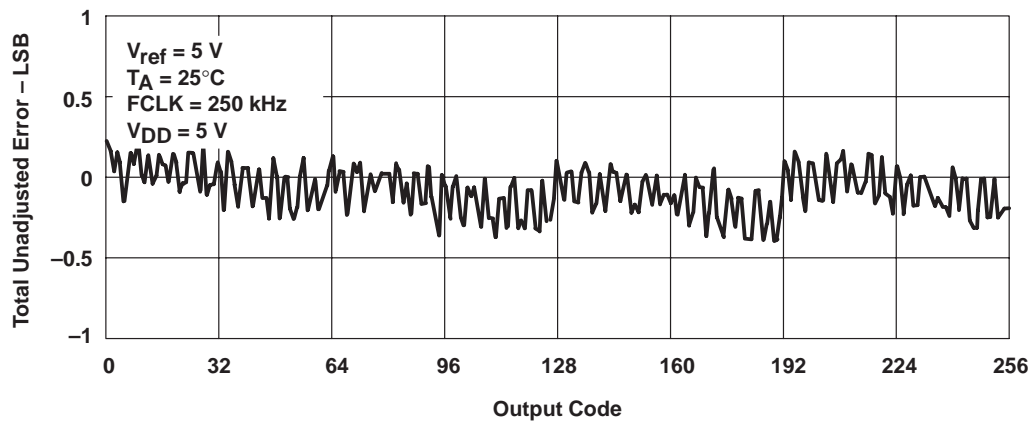

Figure 13. Total Unadjusted Error With Output Code

PACKAGING INFORMATION

Orderable Device	Status ⁽¹⁾	Package Type	Package Drawing	Pins	Package Qty	Eco Plan ⁽²⁾	Lead/ Ball Finish	MSL Peak Temp ⁽³⁾	Samples (Requires Login)
TLC0831CD	ACTIVE	SOIC	D	8	75	Green (RoHS & no Sb/Br)	CU NIPDAU	Level-1-260C-UNLIM	Request Free Samples
TLC0831CDG4	ACTIVE	SOIC	D	8	75	Green (RoHS & no Sb/Br)	CU NIPDAU	Level-1-260C-UNLIM	Request Free Samples
TLC0831CDR	ACTIVE	SOIC	D	8	2500	Green (RoHS & no Sb/Br)	CU NIPDAU	Level-1-260C-UNLIM	Purchase Samples
TLC0831CDRG4	ACTIVE	SOIC	D	8	2500	Green (RoHS & no Sb/Br)	CU NIPDAU	Level-1-260C-UNLIM	Purchase Samples
TLC0831CP	ACTIVE	PDIP	P	8	50	Green (RoHS & no Sb/Br)	CU NIPDAU	N / A for Pkg Type	Request Free Samples
TLC0831CPE4	ACTIVE	PDIP	P	8	50	Green (RoHS & no Sb/Br)	CU NIPDAU	N / A for Pkg Type	Request Free Samples
TLC0831ID	ACTIVE	SOIC	D	8	75	Green (RoHS & no Sb/Br)	CU NIPDAU	Level-1-260C-UNLIM	Request Free Samples
TLC0831IDG4	ACTIVE	SOIC	D	8	75	Green (RoHS & no Sb/Br)	CU NIPDAU	Level-1-260C-UNLIM	Request Free Samples
TLC0831IDR	ACTIVE	SOIC	D	8	2500	Green (RoHS & no Sb/Br)	CU NIPDAU	Level-1-260C-UNLIM	Purchase Samples
TLC0831IDRG4	ACTIVE	SOIC	D	8	2500	Green (RoHS & no Sb/Br)	CU NIPDAU	Level-1-260C-UNLIM	Purchase Samples
TLC0831IP	ACTIVE	PDIP	P	8	50	Green (RoHS & no Sb/Br)	CU NIPDAU	N / A for Pkg Type	Request Free Samples
TLC0831IPE4	ACTIVE	PDIP	P	8	50	Green (RoHS & no Sb/Br)	CU NIPDAU	N / A for Pkg Type	Request Free Samples
TLC0832CD	ACTIVE	SOIC	D	8	75	Green (RoHS & no Sb/Br)	CU NIPDAU	Level-1-260C-UNLIM	Request Free Samples
TLC0832CDG4	ACTIVE	SOIC	D	8	75	Green (RoHS & no Sb/Br)	CU NIPDAU	Level-1-260C-UNLIM	Request Free Samples
TLC0832CDR	ACTIVE	SOIC	D	8	2500	Green (RoHS & no Sb/Br)	CU NIPDAU	Level-1-260C-UNLIM	Purchase Samples
TLC0832CDRG4	ACTIVE	SOIC	D	8	2500	Green (RoHS & no Sb/Br)	CU NIPDAU	Level-1-260C-UNLIM	Purchase Samples
TLC0832CP	ACTIVE	PDIP	P	8	50	Green (RoHS & no Sb/Br)	CU NIPDAU	N / A for Pkg Type	Request Free Samples

Orderable Device	Status ⁽¹⁾	Package Type	Package Drawing	Pins	Package Qty	Eco Plan ⁽²⁾	Lead/ Ball Finish	MSL Peak Temp ⁽³⁾	Samples (Requires Login)
TLC0832CPE4	ACTIVE	PDIP	P	8	50	Green (RoHS & no Sb/Br)	CU NIPDAU	N / A for Pkg Type	Request Free Samples
TLC0832ID	ACTIVE	SOIC	D	8	75	Green (RoHS & no Sb/Br)	CU NIPDAU	Level-1-260C-UNLIM	Request Free Samples
TLC0832IDG4	ACTIVE	SOIC	D	8	75	Green (RoHS & no Sb/Br)	CU NIPDAU	Level-1-260C-UNLIM	Request Free Samples
TLC0832IDR	ACTIVE	SOIC	D	8	2500	Green (RoHS & no Sb/Br)	CU NIPDAU	Level-1-260C-UNLIM	Purchase Samples
TLC0832IDRG4	ACTIVE	SOIC	D	8	2500	Green (RoHS & no Sb/Br)	CU NIPDAU	Level-1-260C-UNLIM	Purchase Samples
TLC0832IP	ACTIVE	PDIP	P	8	50	Green (RoHS & no Sb/Br)	CU NIPDAU	N / A for Pkg Type	Request Free Samples
TLC0832IPE4	ACTIVE	PDIP	P	8	50	Green (RoHS & no Sb/Br)	CU NIPDAU	N / A for Pkg Type	Request Free Samples

⁽¹⁾ The marketing status values are defined as follows:

ACTIVE: Product device recommended for new designs.

LIFEBUY: TI has announced that the device will be discontinued, and a lifetime-buy period is in effect.

NRND: Not recommended for new designs. Device is in production to support existing customers, but TI does not recommend using this part in a new design.

PREVIEW: Device has been announced but is not in production. Samples may or may not be available.

OBSOLETE: TI has discontinued the production of the device.

⁽²⁾ Eco Plan - The planned eco-friendly classification: Pb-Free (RoHS), Pb-Free (RoHS Exempt), or Green (RoHS & no Sb/Br) - please check <http://www.ti.com/productcontent> for the latest availability information and additional product content details.

TBD: The Pb-Free/Green conversion plan has not been defined.

Pb-Free (RoHS): TI's terms "Lead-Free" or "Pb-Free" mean semiconductor products that are compatible with the current RoHS requirements for all 6 substances, including the requirement that lead not exceed 0.1% by weight in homogeneous materials. Where designed to be soldered at high temperatures, TI Pb-Free products are suitable for use in specified lead-free processes.

Pb-Free (RoHS Exempt): This component has a RoHS exemption for either 1) lead-based flip-chip solder bumps used between the die and package, or 2) lead-based die adhesive used between the die and leadframe. The component is otherwise considered Pb-Free (RoHS compatible) as defined above.

Green (RoHS & no Sb/Br): TI defines "Green" to mean Pb-Free (RoHS compatible), and free of Bromine (Br) and Antimony (Sb) based flame retardants (Br or Sb do not exceed 0.1% by weight in homogeneous material)

⁽³⁾ MSL, Peak Temp. -- The Moisture Sensitivity Level rating according to the JEDEC industry standard classifications, and peak solder temperature.

Important Information and Disclaimer: The information provided on this page represents TI's knowledge and belief as of the date that it is provided. TI bases its knowledge and belief on information provided by third parties, and makes no representation or warranty as to the accuracy of such information. Efforts are underway to better integrate information from third parties. TI has taken and continues to take reasonable steps to provide representative and accurate information but may not have conducted destructive testing or chemical analysis on incoming materials and chemicals. TI and TI suppliers consider certain information to be proprietary, and thus CAS numbers and other limited information may not be available for release.

In no event shall TI's liability arising out of such information exceed the total purchase price of the TI part(s) at issue in this document sold by TI to Customer on an annual basis.

TAPE AND REEL INFORMATION



QUADRANT ASSIGNMENTS FOR PIN 1 ORIENTATION IN TAPE



*All dimensions are nominal

Device	Package Type	Package Drawing	Pins	SPQ	Reel Diameter (mm)	Reel Width W1 (mm)	A0 (mm)	B0 (mm)	K0 (mm)	P1 (mm)	W (mm)	Pin1 Quadrant
TLC0831CDR	SOIC	D	8	2500	330.0	12.4	6.4	5.2	2.1	8.0	12.0	Q1
TLC0831IDR	SOIC	D	8	2500	330.0	12.4	6.4	5.2	2.1	8.0	12.0	Q1
TLC0832CDR	SOIC	D	8	2500	330.0	12.4	6.4	5.2	2.1	8.0	12.0	Q1
TLC0832IDR	SOIC	D	8	2500	330.0	12.4	6.4	5.2	2.1	8.0	12.0	Q1

TAPE AND REEL BOX DIMENSIONS



*All dimensions are nominal

Device	Package Type	Package Drawing	Pins	SPQ	Length (mm)	Width (mm)	Height (mm)
TLC0831CDR	SOIC	D	8	2500	346.0	346.0	29.0
TLC0831IDR	SOIC	D	8	2500	346.0	346.0	29.0
TLC0832CDR	SOIC	D	8	2500	346.0	346.0	29.0
TLC0832IDR	SOIC	D	8	2500	346.0	346.0	29.0

P (R-PDIP-T8)

PLASTIC DUAL-IN-LINE PACKAGE



4040082/E 04/2010

- NOTES:
- A. All linear dimensions are in inches (millimeters).
 - B. This drawing is subject to change without notice.
 - C. Falls within JEDEC MS-001 variation BA.

D (R-PDSO-G8)

PLASTIC SMALL OUTLINE



NOTES: A. All linear dimensions are in inches (millimeters).
 B. This drawing is subject to change without notice.
 C. Body length does not include mold flash, protrusions, or gate burrs. Mold flash, protrusions, or gate burrs shall not exceed 0.006 (0,15) each side.
 D. Body width does not include interlead flash. Interlead flash shall not exceed 0.017 (0,43) each side.
 E. Reference JEDEC MS-012 variation AA.

IMPORTANT NOTICE

Texas Instruments Incorporated and its subsidiaries (TI) reserve the right to make corrections, modifications, enhancements, improvements, and other changes to its products and services at any time and to discontinue any product or service without notice. Customers should obtain the latest relevant information before placing orders and should verify that such information is current and complete. All products are sold subject to TI's terms and conditions of sale supplied at the time of order acknowledgment.

TI warrants performance of its hardware products to the specifications applicable at the time of sale in accordance with TI's standard warranty. Testing and other quality control techniques are used to the extent TI deems necessary to support this warranty. Except where mandated by government requirements, testing of all parameters of each product is not necessarily performed.

TI assumes no liability for applications assistance or customer product design. Customers are responsible for their products and applications using TI components. To minimize the risks associated with customer products and applications, customers should provide adequate design and operating safeguards.

TI does not warrant or represent that any license, either express or implied, is granted under any TI patent right, copyright, mask work right, or other TI intellectual property right relating to any combination, machine, or process in which TI products or services are used. Information published by TI regarding third-party products or services does not constitute a license from TI to use such products or services or a warranty or endorsement thereof. Use of such information may require a license from a third party under the patents or other intellectual property of the third party, or a license from TI under the patents or other intellectual property of TI.

Reproduction of TI information in TI data books or data sheets is permissible only if reproduction is without alteration and is accompanied by all associated warranties, conditions, limitations, and notices. Reproduction of this information with alteration is an unfair and deceptive business practice. TI is not responsible or liable for such altered documentation. Information of third parties may be subject to additional restrictions.

Resale of TI products or services with statements different from or beyond the parameters stated by TI for that product or service voids all express and any implied warranties for the associated TI product or service and is an unfair and deceptive business practice. TI is not responsible or liable for any such statements.

TI products are not authorized for use in safety-critical applications (such as life support) where a failure of the TI product would reasonably be expected to cause severe personal injury or death, unless officers of the parties have executed an agreement specifically governing such use. Buyers represent that they have all necessary expertise in the safety and regulatory ramifications of their applications, and acknowledge and agree that they are solely responsible for all legal, regulatory and safety-related requirements concerning their products and any use of TI products in such safety-critical applications, notwithstanding any applications-related information or support that may be provided by TI. Further, Buyers must fully indemnify TI and its representatives against any damages arising out of the use of TI products in such safety-critical applications.

TI products are neither designed nor intended for use in military/aerospace applications or environments unless the TI products are specifically designated by TI as military-grade or "enhanced plastic." Only products designated by TI as military-grade meet military specifications. Buyers acknowledge and agree that any such use of TI products which TI has not designated as military-grade is solely at the Buyer's risk, and that they are solely responsible for compliance with all legal and regulatory requirements in connection with such use.

TI products are neither designed nor intended for use in automotive applications or environments unless the specific TI products are designated by TI as compliant with ISO/TS 16949 requirements. Buyers acknowledge and agree that, if they use any non-designated products in automotive applications, TI will not be responsible for any failure to meet such requirements.

Following are URLs where you can obtain information on other Texas Instruments products and application solutions:

Products

Audio	www.ti.com/audio
Amplifiers	amplifier.ti.com
Data Converters	dataconverter.ti.com
DLP® Products	www.dlp.com
DSP	dsp.ti.com
Clocks and Timers	www.ti.com/clocks
Interface	interface.ti.com
Logic	logic.ti.com
Power Mgmt	power.ti.com
Microcontrollers	microcontroller.ti.com
RFID	www.ti-rfid.com
RF/IF and ZigBee® Solutions	www.ti.com/lprf

Applications

Communications and Telecom	www.ti.com/communications
Computers and Peripherals	www.ti.com/computers
Consumer Electronics	www.ti.com/consumer-apps
Energy and Lighting	www.ti.com/energy
Industrial	www.ti.com/industrial
Medical	www.ti.com/medical
Security	www.ti.com/security
Space, Avionics and Defense	www.ti.com/space-avionics-defense
Transportation and Automotive	www.ti.com/automotive
Video and Imaging	www.ti.com/video
Wireless	www.ti.com/wireless-apps

TI E2E Community Home Page

e2e.ti.com

Mailing Address: Texas Instruments, Post Office Box 655303, Dallas, Texas 75265
Copyright © 2011, Texas Instruments Incorporated