

# Dual Busy Tone Multiple Access (DBTMA)— A Multiple Access Control Scheme for Ad Hoc Networks

Zygmunt J. Haas, *Senior Member, IEEE*, and Jing Deng, *Student Member, IEEE*

**Abstract**—In ad hoc networks, the hidden- and the exposed-terminal problems can severely reduce the network capacity on the MAC layer. To address these problems, the ready-to-send and clear-to-send (RTS/CTS) dialogue has been proposed in the literature. However, MAC schemes using only the RTS/CTS dialogue cannot completely solve the hidden and the exposed terminal problems, as pure “packet sensing” MAC schemes are not safe even in fully connected networks. We propose a new MAC protocol, termed the dual busy tone multiple access (DBTMA) scheme. The operation of the DBTMA protocol is based on the RTS packet and two narrow-bandwidth, out-of-band busy tones. With the use of the RTS packet and the receive busy tone, which is set up by the receiver, our scheme completely solves the hidden- and the exposed-terminal problems. The busy tone, which is set up by the transmitter, provides protection for the RTS packets, increasing the probability of successful RTS reception and, consequently, increasing the throughput. This paper outlines the operation rules of the DBTMA scheme and analyzes its performance. Simulation results are also provided to support the analytical results. It is concluded that the DBTMA protocol is superior to other schemes that rely on the RTS/CTS dialogue on a single channel or to those that rely on a single busy tone. As a point of reference, the DBTMA scheme out-performs FAMA-NCS by 20–40% in our simulations using the network topologies borrowed from the FAMA-NCS paper. In an ad hoc network with a large coverage area, DBTMA achieves performance gain of 140% over FAMA-NCS and performance gain of 20% over RI-BTMA.

**Index Terms**—Ad hoc networks, busy tone, exposed-terminal, FAMA, hidden-terminal, MAC, MACA, MACAW, medium access control, RTS/CTS.

## I. INTRODUCTION

**A**N ad hoc network is a collection of wireless hosts forming a temporary network without relying on an established infrastructure or on a central control. Network operations, such as routing, are performed in a distributed and cooperative manner. The applications of ad hoc networks are in situations in which the network needs to be deployed rapidly, such as communications in emergency situations. Recently, the Bluetooth [2] technology was introduced and, as discussed by Haartsen in [1], the

Paper approved by Y. Fang, the Editor for Multiple Access of the IEEE Communications Society. Manuscript received July 24, 2000; revised May 4, 2001, September 6, 2001, and November 1, 2001. This work was supported in part by the DoD Multidisciplinary University Research Initiative (MURI) program administered by the Office of Naval Research under Grant N00014-00-1-0564 and by the Air Force Rome Labs Contract F360602-97-C-0133.

The authors are with the Wireless Networks Laboratory, School of Electrical and Computer Engineering, Cornell University, Ithaca, NY 14853 USA (e-mail: haas@ece.cornell.edu; jing@ece.cornell.edu).

Publisher Item Identifier S 0090-6778(02)05550-2.

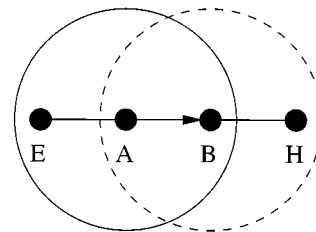

Fig. 1. Hidden/exposed terminals.

Bluetooth devices can form an ad hoc network to communicate with each other. Due to the large span of ad hoc networks and limited radio transmission range, multi-hop routing is usually used, in which the communication between any two nodes is performed by forwarding the data packet from one node to another until the packet reaches the destination.

In a single-channel ad hoc network, one channel is shared by a number of communicating nodes located in close proximity. The throughput of such a network depends largely upon the performance of the Multiple Access Control (MAC) protocol in use, which controls and coordinates the access of the nodes to the shared channel. In order to increase the throughput, many MAC schemes, such as Carrier Sensing Multiple Access (CSMA) by Kleinrock and Tobagi in [3] and CSMA with Collision Avoidance (CSMA/CA) by Colvin in [4], require nodes to sense the common channel before packet transmission. However, collisions, which arise when more than one packet is received at a node at the same time, are still possible. Two phenomena have major impacts on the capacity of ad hoc networks: the hidden and the exposed terminal problems.

*Hidden terminals* (e.g., node H in Fig. 1) are the nodes in the range of the receiver (node B) but out of the range of the transmitter (node A). Since collisions occur at the receiver, sensing the common channel before an attempt to access the channel will not, in general, eliminate access collisions, which reduce the network capacity for transmission of useful data. This is referred to as the *hidden-terminal problem*. While the transmissions of the hidden terminals may destroy data packets at the receiver, the hidden terminals should, however, be allowed to **receive** data packets. Of course, proper design is required to allow hidden terminals to announce that they are free to receive.

On the other hand, the *exposed-terminal* problem, as discussed by Karn in [5], comes about when nodes are in the range of the transmitter but not the receiver, such as node E in Fig. 1. If the regular carrier sensing mechanism is used, the exposed terminals will defer from accessing the shared channel,

although in such cases parallel communication can take place to increase the network utilization. The culprit is, again, the fact that the collisions occur at the receiver, while channel sensing schemes test the channel condition at the transmitter.

From the above discussion, it is clear that pure carrier sensing mechanism, e.g., the CSMA scheme in the work by Tobagi and Kleinrock [6], does not suffice to achieve high network utilization in ad hoc networks. Many other MAC protocols have been proposed, attempting to address the hidden- and the exposed-terminal problems (e.g., [5]–[7]). Specifically, in works by Karn [5] and Bharghavan *et al.* [7], the ready-to-send and clear-to-send (RTS/CTS) dialogue is used. However, these RTS/CTS type MAC protocols solve neither the hidden- nor the exposed-terminal problems. The reason is that, although exposed terminals are permitted to send their RTS packets to request the channel, they will not receive any CTS replies while another node is transmitting on the single channel. Also, the hidden terminals still cannot receive, as they are forbidden to access the channel (including replying to RTS packets). With these packet-sensing protocols, packets are at risk for collisions, including in a fully connected topology.

In this paper, we propose the dual busy tone multiple access (DBTMA) protocol. In DBTMA, we use the RTS packets to initiate channel request. Two out-of-band busy tones are then used to protect the RTS packets and the data packets, respectively. One of the busy tones, the transmit busy tone,  $BT_t$ , which is set up by the RTS transmitter, is used to protect the RTS packets. Another busy tone, the receive busy tone,  $BT_r$ , which is set up by the receiver, acknowledges the RTS packet and provides continuous protection for the in-coming data packets. Nodes sensing any busy tone defer from sending their RTS packets on the channel. With the use of the RTS packet and the  $BT_r$  signal, the exposed terminals are able to initiate data packet transmissions. Furthermore, the hidden terminals can reply to RTS requests and initiate data packet reception, while data packet transmission is taking place between the transmitter and the receiver.

In this paper, we present the operational rules of the DBTMA protocol in Section III and we analyze the performance of the scheme in Section IV. We provide simulation results in Section V, illustrating the performance of DBTMA, supporting the analytical results, and comparing it with other related schemes. The conclusion from our study, which we present in the last section, is that the DBTMA protocol is superior to other schemes that rely on the RTS/CTS dialogue on a single channel or to those that rely on a single busy tone. But, first, we discuss related works in the next section.

## II. RELATED WORKS

In [6], Tobagi and Kleinrock introduced a scheme that uses a busy tone to address the hidden terminal problem. The protocol, named busy tone multiple access (BTMA), relies on a centralized network operation; i.e., a network with base stations. When a base station senses the transmission of a terminal, it broadcasts a busy tone signal to all terminals, keeping them (except the current transmitter) from accessing the channel. The original

BTMA was proposed to be used in a network with a base station and the scheme uses the busy tone in a centralized manner. Although the protocol could be used in ad hoc networks with distributed control, to our knowledge, the performance of the scheme has not been investigated in such networks.

Tobagi and Kleinrock proposed and studied the Split-channel Reservation Multiple Access (SRMA) scheme for a network with a number of terminals and one central station in [8]. The whole channel is split into two sub-channels for message transmission and control packet transmission (RAM mode), or three sub-channels for message transmission, request transmission, and answer-to-request transmission (RA mode). A ready node sends its request to the central station on the request channel in an ALOHA or CSMA manner. Successful requests will be acknowledged by the central station before the data packet is transmitted.

In the Receiver-Initiated Busy-Tone Multiple Access scheme (RI-BTMA) proposed by Wu and Li [9], a packet preamble is sent to the intended receiver by the transmitter. Once the preamble is received correctly, the receiver sets up an out-of-band busy tone and waits for the data packet. The transmitter, upon sensing the busy tone, sends the data packet to the destination. The busy tone serves two functions: to acknowledge the channel access request and to prevent transmissions from other nodes. RI-BTMA was proposed to be used in the slotted manner. The correct operation of RI-BTMA depends largely on the synchronization of slots, which is usually difficult to achieve globally in a distributed ad hoc networking environment, especially of the mobile type.

In multiple access collision avoidance (MACA) [5], Karn originally proposed the use of short control packets, the request-to-send (RTS) and the clear-to-send (CTS) packets, for collision avoidance on the shared channel. A ready node transmits an RTS packet to request the channel. The receiver replies with a CTS packet. The reception of the CTS packet acknowledges that the RTS/CTS dialogue has been successful and starts the transmission of the actual data packet. All other nodes that hear the RTS packet back off for a time long enough for the transmitter to receive the CTS packet. All other nodes that hear the CTS packet back off for a time long enough for the receiver to receive the data packet. However, when hidden terminals are present, the MACA protocol degenerates to ALOHA. MACA was proposed to address the hidden/exposed terminal problems, but, in fact, these problems are not fully solved by the scheme.

Bharghavan [7] suggested the use of the RTS-CTS-DS-DATA-ACK message exchange for a data packet transmission in the MACAW protocol. The DS (Data Sending) packet was added to notify all nodes in the transmitter's range of its following use of the shared channel. The ACK packet was included for immediate acknowledgment and for fast retransmission of collided data packets. A new back-off algorithm, the multiple increase and linear decrease (MILD) algorithm, was also proposed in the paper to address some of the unfairness problems in accessing the shared channel. Additional features of the MILD algorithm, such as back-off interval copying and multiple back-off intervals for different destinations, further improve the performance of MACAW. However, similar to MACA, MACAW solves neither the hidden- nor the exposed-terminal problems.

In [10], Fullmer and Garcia-Luna-Aceves proposed the floor acquisition multiple access (FAMA) scheme. In FAMA, each ready node has to acquire the channel (the “floor”) before it can use the channel to transmit its data packets. FAMA uses both carrier sensing and RTS/CTS dialogue to ensure the acquisition of the “floor” and the successful transmission of the data packets. In [11], FAMA-NPS (FAMA Non-persistent Packet Sensing) was studied and it was shown that “packet sensing” schemes, such as in FAMA-NPS, MACA, and MACAW, could not solve the hidden/exposed terminal problems.

FAMA was further extended to FAMA-NCS (FAMA Non-persistent Carrier Sensing). FAMA-NCS, with the use of the carrier sensing scheme and longer CTS packets, provides a “CTS dominance” mechanism to ensure correct floor acquisition and collision-free data packet reception. Once a node has begun the transmission of a CTS packet, any other node within its range that simultaneously transmits an RTS packet will hear at least a portion of the dominating CTS packet after returning from transmit mode. Such a node will then backoff from accessing the channel. In FAMA-NCS, no CTS packet will ever collide with a data packet. However, the “CTS dominance” mechanism may have adverse effect when RTS packet collisions take place. When nodes sense the carrier of collided packets, they mistakenly treat these collided RTS packets to be “CTS dominance,” which inhibits them from sending any packet for a time long enough to receive a data packet. The channel capacity is wasted. This false “CTS dominance” effect is more severe when FAMA-NCS operates in ad hoc networks with hidden terminals, where RTS collisions happen more frequently under heavy traffic even with the use of carrier sensing. Finally, FAMA-NCS does not solve the exposed-terminal problem, although it addresses the hidden-terminal problem successfully.

In the IEEE 802.11 MAC layer protocol [12], an access method called Distributed Coordination Function (DCF), which implements the CSMA/CA protocol proposed in the work by Colvin [4], is used. It is an extension to the basic RTS/CTS dialogue: after sensing the channel free, an RTS packet will be sent and the CTS packet indicating the readiness to receive the data at the receiver will be transmitted back to the source. This scheme is similar to the MACA protocol, with the addition of the CSMA mechanism. While the CSMA scheme lowers the probability of RTS packet collisions, IEEE 802.11 MAC layer protocol solves neither the hidden- nor the exposed-terminal problems.

In [13], Gummalla and Limb proposed a wireless collision detection (WCD) scheme based on their transceiver architecture design, in which a feedback channel is implanted in the main data channel. The WCD scheme was proposed to be used in high speed distributed wireless LAN, in which the turn-around time of the half-duplex radio becomes significant compared with packet transmissions time. Every neighbor node sensing the start of the data packet transmission sets up the feedback signal before the end of the receiver detection interval (RDI). The feedback signal inhibits any transmission from all neighbors during RDI. This effectively inhibits all 2-hop neighbors of the transmitter to transmit during this period of time. After RDI, the intended destination decodes the header of the data packet, matching the destination ID on the header and local ID,

and leaves the feedback signal on, while all other neighbors set off the feedback signal. The feedback signal, after the RDI period, works as the confirmation of the transmitted data packet and notification to neighbor nodes. By sensing the feedback signal after RDI, the transmitter keeps transmitting the packet. If no feedback signal is sensed after RDI, the transmitter stops the transmission.

Except for the use of the feedback signal generated from the neighbors of the RTS sender in RDI, the WCD scheme is very similar to the RI-BTMA scheme in operational rules. Operating in slotted manner, the WCD scheme requires network-wide time synchronization, which could be more difficult to achieve in ad hoc networks compared with wireless LANs.

Protection of the data packets at the receiver has to be guaranteed to achieve good performance of a MAC protocol in ad hoc networks. The RTS/CTS dialogue was introduced to prevent all other nodes in the receiver’s range from using the channel. However, the use of this dialogue on a single channel cannot solve the hidden- and the exposed-terminal problems, although FAMA-NCS does solve the hidden-terminal problem with the help of the carrier sensing mechanism. The use of in-band CTS packet effectively inhibits the data transmission of the exposed terminals and the data reception of the hidden terminals. Furthermore, as there is still the possibility of CTS packet collisions at the neighbor nodes, collisions of data packets are inevitable, unless an additional mechanism is provided to protect data packets. In particular, since a CTS packet may not be received correctly at some neighbors, these nodes might send their RTS requests on the channel during the time the data packet is being received, leading to the destruction of the data packet. To address these problems, we have introduced here the DBTMA scheme, whose operation rules are given in the following section.

### III. THE DBTMA PROTOCOL

In the DBTMA protocol, two narrow-bandwidth tones are implemented with enough spectral separation on the single shared channel.  $BT_t$  (the transmit busy tone) and  $BT_r$  (the receive busy tone), indicate whether the node is transmitting RTS packets or receiving data packets, respectively. The transmit busy tone ( $BT_t$ ) provides protection for the RTS packets to increase the probability of successful RTS reception at the intended receiver. We use the receive busy tone ( $BT_r$ ) to acknowledge the RTS packet and provide continuous protection for the transmitted data packets. All nodes sensing any busy tone are not allowed to send RTS requests. When the start of the  $BT_r$  signal is sensed, a node sending the RTS packet is required to abort such transmission immediately. Indeed, the RTS packets and the receive busy tone solve the hidden- and the exposed-terminal problems.

The operation of the DBTMA protocol will be explained by the way of a network example, shown in Fig. 2. In this figure, a solid line between any two nodes indicates that the nodes can hear each other. Hence, node C is a hidden terminal to the transmission from node A to node B, and node E is an exposed terminal, if it wants, for example, to communicate with node F (but not with node A).

A node implementing the DBTMA protocol can be in one of the following seven states: IDLE, CONTENTEND, S\_RTS, S\_DATA,

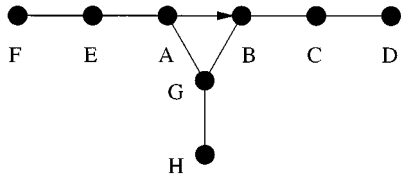

Fig. 2. An example network to demonstrate the hidden- and the exposed-terminal problems.

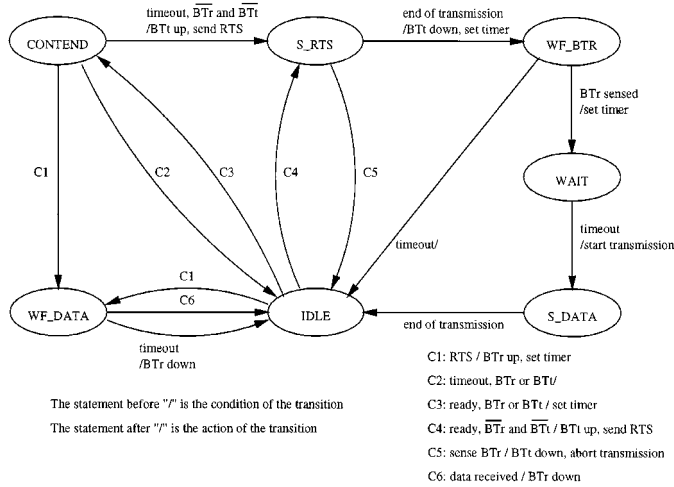

Fig. 3. The finite state machine of DBTMA.

WF\_BTR, WF\_DATA, and WAIT. Fig. 3 depicts the finite state machine (FSM) of the DBTMA scheme. A node with no packets to send stays in the IDLE state. When a node has a packet to send, but it is not allowed to send the RTS packet, it stays in the CONTENTD state. Nodes sending RTS or DATA packets are in the S\_RTS or S\_DATA states, respectively. The RTS packet sender waits for the acknowledgment from its intended receiver in the WF\_BTR state. The receiver waits for the data packet in the WF\_DATA state.

When node A has a data packet to send while it is in the IDLE state, it tries to sense the  $BT_r$  and the  $BT_t$  busy tone signals. If none of the busy signals is present (which means that no one in node A's transmission area is receiving data packet or sending RTS packets), it turns on its  $BT_t$  signal, sends an RTS packet to node B, and goes into the S\_RTS state. Otherwise, it sets a random timer and goes into the CONTENTD state. By the end of the RTS transmission, node A turns off its  $BT_t$  signal, sets a timer, and goes into the WF\_BTR state. When node B receives the RTS packet, it turns on its  $BT_r$  signal, replying to node A and announcing that it is waiting for the incoming data packet. Then it sets up a timer and goes into the WF\_DATA state.

Node A continuously monitors the  $BT_r$  signal when it is in the WF\_BTR state. When a  $BT_r$  signal is sensed, it knows that its channel request has been successful. Before node A sends the data packet, it waits a mandatory waiting time ( $t_{mw} = 2\tau$ ) in the WAIT state.<sup>1</sup> This mandatory waiting time is meant to allow all possible RTS transmissions in the range of the receiver to be aborted. Upon timeout in the WAIT state, node A goes into

<sup>1</sup> $\tau$  is the maximum propagation delay between the transmitter and the receiver.

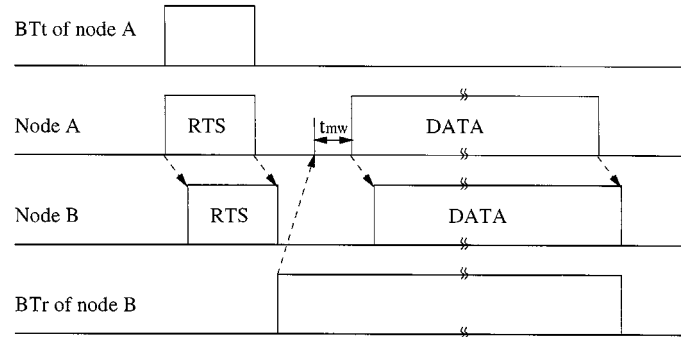

Fig. 4. Time diagram of DBTMA.

the S\_DATA state and sends the data packet. By the end of its transmission, node A goes into the IDLE state. Upon successful reception of the data packet, node B turns off the  $BT_r$  signal and goes into the IDLE state, ending the communication. If, for any reason, node B does not receive the data packet before the timer expires, it turns off the  $BT_r$  signal and goes into the IDLE state.

Upon timeout in the CONTENTD state, node A turns on its  $BT_t$  signal and sends its RTS packet if no busy tone signal is sensed. Otherwise, it goes back into the IDLE state. From the perspective of the other nodes in the neighborhood, their operations can be described as following: When the  $BT_t$  and/or the  $BT_r$  signal is sensed, a node (e.g., node E, G, or C) is not allowed to send any RTS request. When the start of a  $BT_r$  signal is sensed while a node (e.g., node G or C) is in the S\_RTS state, it aborts its RTS transmission, turns off its  $BT_t$  signal, and goes back to the IDLE state.

We show the time diagram with the operation of node A and node B in Fig. 4. Additional details of the DBTMA operation rules are presented in Appendix I.

#### IV. PERFORMANCE ANALYSIS

In order to study the performance of the DBTMA protocol, we adopt the method developed by Tobagi and Kleinrock in their study of CSMA and BTMA [6] and further used by Fullmer and Garcia-Luna-Aceves in FAMA [11]. The network model consists of a large number of terminals communicating with each other over a single channel. All nodes are within the range of each other. We make the following assumptions for the DBTMA protocol and the analysis:

- The radio transmission range of the ad hoc network in which the DBTMA scheme operates is on the order of tens to hundred of meters. There is no capture effect or fading on the channel.
- Any overlap of transmissions at a receiver causes the receiver to not understand either packet. Packet collisions are the only source of packet errors.
- The data processing time and the transmit/receive turnaround time at each node are negligible.
- The busy tone signal and the data signal have the same transmission range.
- The interference between the busy tone signals and the data signal is negligible.

- The bandwidth consumption of the busy tones is negligible compared to the bandwidth of the data channel.<sup>2</sup>
- The data packet transmission time, the RTS packet transmission time, and the maximum one way propagation delay are  $\delta$ ,  $\gamma$ , and  $\tau$ , respectively.
- The busy tone detection delay is  $t_d$ , which depends on the communication hardware and might not, in general, be negligible.
- The mandatory waiting time is set to  $t_{wm} = 2\tau$ .
- The transmission time of the RTS packet ( $\gamma$ ) is larger than  $t_d + 4\tau$ .
- The network has a large number of nodes, which collectively generate a Poisson traffic with mean aggregate rate of  $\lambda$  channel requests per second.

We further assume that the radio signal propagation delay between any two nodes is  $\tau$ , hence the channel capacity we obtain is a lower bound.

We treat the transmission cycle on the channel as a renewal process. We define a busy period as the time between two consecutive idle periods, in which there is a transmission on the shared channel. A busy period might be a period with successful data transmission, or a period with packet collisions. The channel throughput, as discussed by Kleinrock and Tobagi in [3], can be expressed as

$$S = \frac{\bar{U}}{\bar{B} + \bar{I}} \quad (1)$$

where  $\bar{U}$ ,  $\bar{B}$ , and  $\bar{I}$  are the average utilization time for data packet transmission, the average busy time, and the average idle time of the channel, respectively, in each cycle.

An RTS packet originated from any node (e.g., node A) is successful if no other RTS packets are sent in the first  $t_d + \tau$  seconds. Because this is the sum of the busy tone detection delay and the maximum propagation delay, the  $BT_i$  signal set up by node A will be sensed by all nodes after  $t_d + \tau$  seconds. So the probability of success of the RTS packet from node A is the probability that there is no arrival during this period of time:

$$P_s = e^{-\lambda(t_d + \tau)}. \quad (2)$$

When the RTS packet is successfully received at the intended receiver (e.g., node B), it will set up its  $BT_r$  signal and wait for the data packet. We argue that when the RTS packet is successfully received and the  $BT_r$  signal is set up, data packet reception will be guaranteed. An intuitive explanation is the following: All nodes sensing the  $BT_r$  signal will abort their RTS transmissions and keep silent. There must not be any other node sending data packets in the range of node B. Otherwise, node B would not have received the RTS packet successfully. Appendix II presents the theorem and its proof.

A successful transmission period ( $T_s$ ) consists of the transmission time of an RTS packet plus the propagation delay, the busy tone detection delay plus the propagation delay, the mandatory waiting time ( $t_{mw} = 2\tau$ ), the transmission time of the data

<sup>2</sup>As discussed by Tobagi and Kleinrock in [6], the bandwidth consumption of a busy tone signal could be in the range of 0.1–10 KHz with the main data channel of 100 KHz. Although we can't find any data sheet on busy tone hardware implementations, we expect that each of the busy tones can be implemented within the bandwidth of 10 KHz.

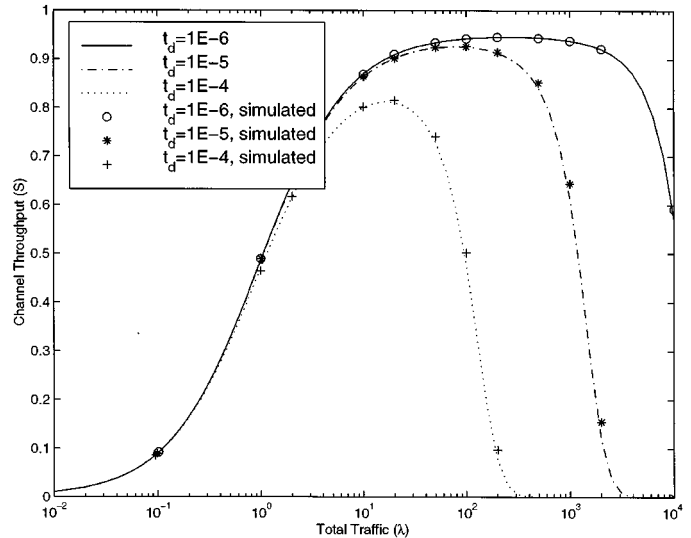

Fig. 5. Channel throughput of DBTMA with different  $t_d$ .

packet plus the propagation delay, and the period of time for the  $BT_r$  signal to be cleared from the channel ( $\tau$ ). So  $T_s$  is

$$\begin{aligned} T_s &= \gamma + \tau + t_d + \tau + t_{mw} + \delta + \tau + \tau \\ &= \delta + \gamma + t_d + 6\tau. \end{aligned} \quad (3)$$

A failed busy period ( $T_f$ ) consists of more than one RTS packet. Since no new RTS packets will be sent  $t_d + \tau$  seconds after the start of node A's RTS packet, the longest failed busy period is  $\gamma + t_d + \tau$ . The shortest failed busy period is the situation when more than one RTS packets are sent at approximately the same time, with the failed busy period as  $\gamma + \tau$ . We assume that the colliding RTS packet arrives uniformly in the duration of  $[0, t_d + \tau]$ , so the average failed busy period is the average of the longest and the shortest value

$$T_f = \frac{\gamma + t_d + \tau + \gamma + \tau}{2} = \gamma + \tau + \frac{t_d}{2}. \quad (4)$$

The average busy period is therefore

$$\bar{B} = P_s T_s + (1 - P_s) T_f. \quad (5)$$

The average utilization time is the product of the probability of a successful busy period and the data packet transmission time:

$$\bar{U} = P_s \delta. \quad (6)$$

The average idle period is the average inter-arrival time of RTSs from all nodes. Since the RTS packets arrive according to the Poisson distribution, we have

$$\bar{I} = \frac{1}{\lambda}. \quad (7)$$

Substituting (5)–(7) into (1), we obtain the channel throughput of the DBTMA protocol in the discussed network model

$$S = \frac{P_s \delta}{P_s (\delta + \gamma + t_d + 6\tau) + (1 - P_s) T_f + 1/\lambda} \quad (8)$$

where  $P_s$  and  $T_f$  are given by (2) and (4), respectively.

In Fig. 5, we draw the channel throughput of DBTMA for different busy tone detection delay ( $t_d$ ). In the figure, we considered a wireless network with channel data rate of 1 Mb/s. The

data packet length is 4096 b and the RTS packet length is 200 b. There are 20 nodes in the  $50 \times 50 \text{ m}^2$  network. The radio transmission range is 35 m, which is the maximal distance between any two nodes,<sup>3</sup> with a maximum one-way propagation delay of  $0.12 \mu\text{s}$ . The considered busy tone detection delays ( $t_d$ ) are  $10^{-6}$ ,  $10^{-5}$ , and  $10^{-4}$  s. Each simulation represents 100 s of “real time.” The lines show our analytical results and the symbols represent the simulation results. Good match between analytical results and simulation results is achieved. The small discrepancy can be attributed to the finite number of nodes in the simulated network and the infinite number of nodes assumed in the analytical model.

It can be observed that the channel throughput for small  $t_d$  is always above 0.9. When  $t_d$  is  $10^{-6}$  s, the channel throughput of DBTMA is 0.94. It decreases to 0.92 when  $t_d$  is changed to  $10^{-5}$  s, because the longer vulnerable period of each RTS packet leads to lower probability of successful RTS requests and larger overhead. When  $t_d$  is  $10^{-4}$  s, which is half of the RTS packet transmission time ( $\gamma$ ), the performance of DBTMA degrades to 0.82. We can also notice the earlier decrease of channel throughput as a function of the traffic load for larger  $t_d$ , because of the longer vulnerable period of the RTS packets.

The analytical results for a non-fully connected network are more difficult to obtain. Hence we resort to simulations.

## V. PERFORMANCE EVALUATION

In order to evaluate the performance of DBTMA, we have simulated ad hoc networks implementing the DBTMA protocol and other related protocols in the OPNET<sup>TM</sup> simulator, in addition to using our own C/C++ simulator. Each of our simulation results represents an average of 10 random runs. When the channel data rate is 1 Mbps, each simulation represents a “real time” of 100 s. The “real time” is 400 s when the channel data rate is 256 Kb/s.

Firstly, we studied the performance of the DBTMA scheme under different hidden terminal situations. We simulated the DBTMA protocol in an ad hoc network with  $N$  ( $N = 1, 2, \dots, 6$ ) independent groups and one common receiver. Each group contains 5 nodes, which are in the transmission range of each other. All these nodes in the  $N$  groups generate data traffic to send to the common receiver (central station), which resides at the center of the network. Fig. 6 shows an example of such a network with  $N = 4$ . We borrowed this network example from the work by Fullmer and Garcia-Luna-Aceves [11]. The length of the RTS packet is 200 b, the length of the data packet is 4096 b, and the channel data rate is 1 Mb/s. The radio transmission range is about 2 km, with propagation delay of  $6.7 \mu\text{s}$ .<sup>4</sup> Fig. 7 compares the DBTMA protocol with the FAMA-NCS protocol<sup>5</sup> and other related MAC protocols in the same environment.

From Fig. 7, we find that the DBTMA scheme has higher channel throughput than any other MAC scheme that we

<sup>3</sup>We assumed the simulated network to be a closed coverage area, which effectively creates a torus. So the four corners are treated as one point in the distance calculation.

<sup>4</sup>We expect the DBTMA scheme to operate in most ad hoc networks with radio transmission range smaller than 1 km. So, these results are meant for comparison purpose only.

<sup>5</sup>In our FAMA-NCS implementation,  $\gamma = 200 \mu\text{s}$  and  $\epsilon = 0$ .

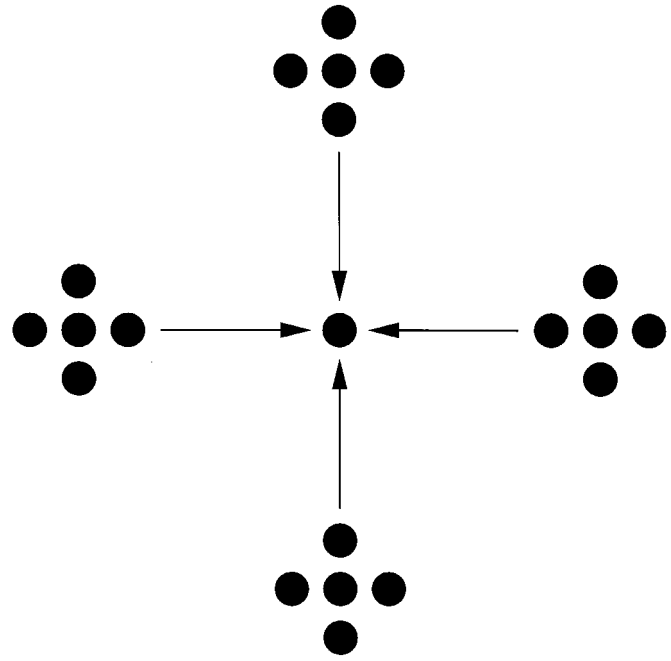

Fig. 6. Exampled network of  $N$  independent groups ( $N = 4$ ).

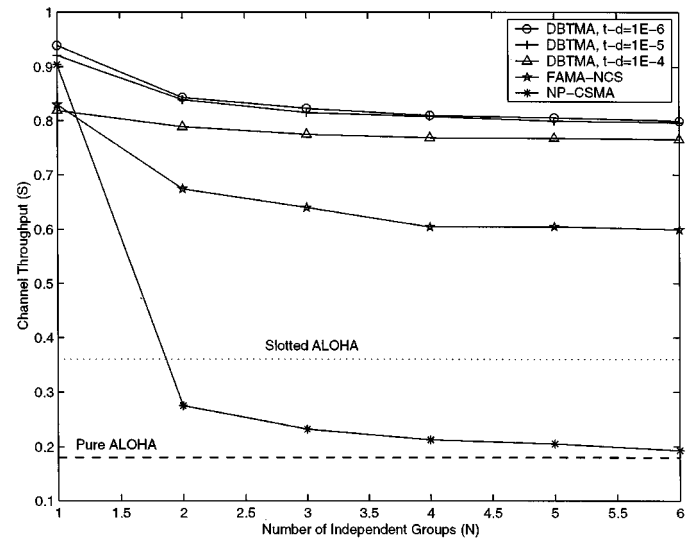

Fig. 7. Channel throughput of DBTMA with different  $N$ .

show on the graph. When  $N = 1$ , DBTMA achieves network utilization of 0.94 for small  $t_d$  and 0.82 when  $t_d$  is  $10^{-4}$  s. The non-persistent CSMA (NP-CSMA) scheme has a throughput of 0.90, while the FAMA-NCS scheme has 0.83. However, the performance of FAMA-NCS scheme degrades to 0.6 when  $N$  increases to 6, because of higher probability of RTS packet collisions and the unnecessary idle time of the channel after RTS collisions (false “CTS dominance”). When  $N$  is 6, the DBTMA protocol has a throughput of 0.8 or 0.77, depending on the value of  $t_d$ . The NP-CSMA scheme degrades quickly as  $N$  increases. Eventually it performs the same as the pure ALOHA, a result which was reported by Kleinrock and Tobagi [6]. For comparison purpose, we also draw the performance of pure ALOHA and slotted ALOHA. Hence, DBTMA increases over FAMA and CSMA with diminishing returns. With hidden

terminal present, as  $N$  increases, CSMA asymptotically approaches ALOHA (18%), and FAMA-NCS approaches MACA (about 60% for a fully connected network).

Hence, for practical values of  $t_d$ , the DBTMA scheme out-performs both the FAMA-NCS and NP-CSMA schemes for these network topologies. As the portion of hidden terminals increases ( $N$  increases), the performance gain of the DBTMA scheme over the other two increases as well. We assume  $t_d = 10^{-6}$  s for the rest of the discussions in this section.

Secondly, we compared the DBTMA protocol and similar protocols for some specific network topologies. To allow meaningful comparison with the FAMA-NCS protocol, we have evaluated the performance of DBTMA in the same network configurations as used in the work by Fullmer and Garcia-Luna-Aceves [11] and depicted in Fig. 8. Fig. 9 shows the simulation results of DBTMA, FAMA-NCS, and MACAW.<sup>6</sup> The channel data rate is 256 Kb/s and nodes are 6 km from each other, with maximum propagation delay of 20  $\mu$ s.

In Fig. 8, a solid line with an arrow represents the direction of the data traffic generated by the source node. A solid line without arrow represents that the two nodes are in the range of each other. Dotted lines with arrows show that the two nodes can overhear each other even though they are not in the same communication group.

In configuration (a) of Fig. 8, all nodes can hear each other and all traffic is directed to the base node. Configuration (b) has two independent groups which share the same receiver. Configuration (c) has two relatively independent communication groups, with two pairs of nodes being able to overhear each other. In configuration (d), eight nodes form a simple multi-hop network.

As reported in Fig. 9, the DBTMA scheme out-performs the FAMA-NCS and the MACAW scheme in these networks. The DBTMA scheme achieves channel throughput of 0.94 in configuration (a), which is 20% higher than that of the FAMA-NCS scheme. In configuration (b), the throughput of the DBTMA scheme is 0.84, which is 40% higher than that of FAMA-NCS. The DBTMA scheme has approximately 20% performance gain over the FAMA-NCS scheme in configuration (c). In configuration (d), the DBTMA scheme achieves higher average channel throughput than the FAMA-NCS scheme does, with a 40% increase.

The explanation for the above results is as follows: Despite the fact that both schemes provide correct protection for data packet reception, the DBTMA scheme completely solves the hidden- and the exposed-terminal problems, while the FAMA-NCS scheme does not address the exposed-terminal problem. For example, concurrent transmissions such as  $N1$  to  $N6$  and  $N4$  to  $N7$  (or,  $N2$  to  $N5$  and  $N3$  to  $N8$ ) in configuration (d) are possible in the DBTMA scheme, but they are not allowed in the FAMA-NCS scheme. The FAMA-NCS scheme also mistakenly treats collided RTS packets as “CTS dominance” and the channel is wasted while being idle. With the presence of hidden terminals in configuration (b) and (d), the probability of RTS packet collisions is higher, leading to more severe false “CTS dominance” problem.

<sup>6</sup>We didn't implement MACAW in our simulator, but borrowed the results from the work by Fullmer and Garcia-Luna-Aceves in [11].

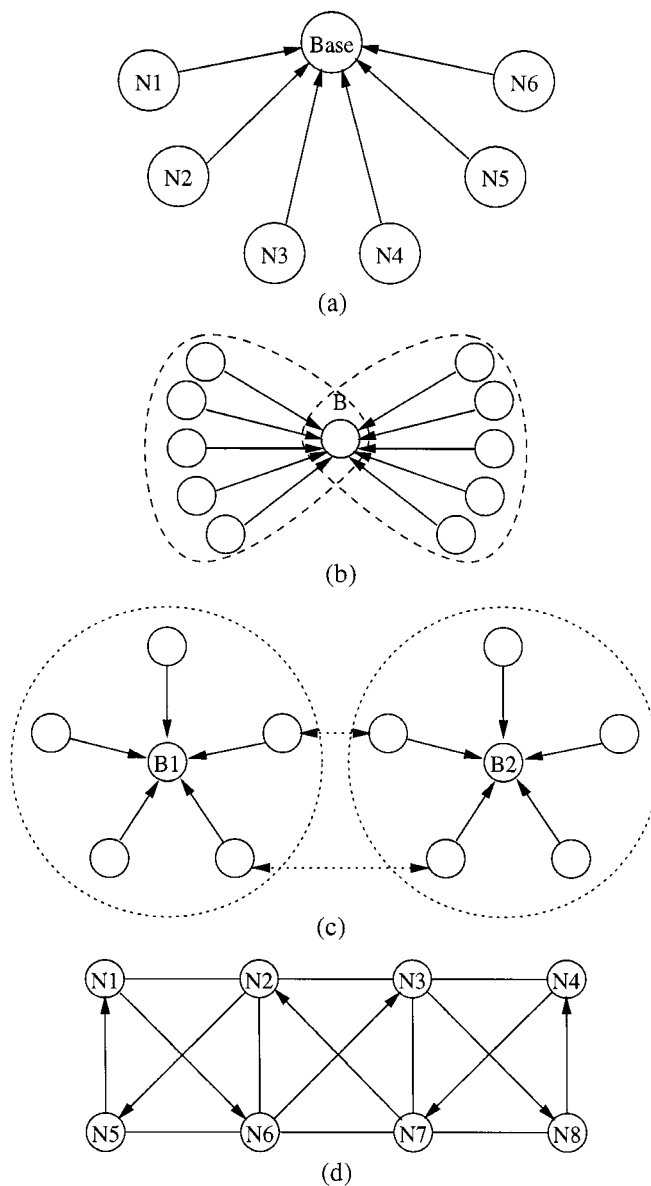

Fig. 8. Simulated topologies.

Configuration	DBTMA	FAMA-NCS	MACAW
(a)	.94	.78	.63
(b)	.84	.59	.49
(c) B1	.94	.75	.45
(c) B2	.94	.75	.39
(d) average	.69	.49	.06
(d) N1, 4, 5, 8	.90	.57	.07
(d) N2, 3, 6, 7	.48	.42	.05

Fig. 9. Channel throughput comparisons.

We have also simulated and studied the DBTMA protocol in other network operational conditions. In Fig. 10, we show the effect of the ratio of the RTS packet length and the data packet length ( $L_r/L_d$ ) in a fully connected network, in which every node chooses its destination randomly for each generated data

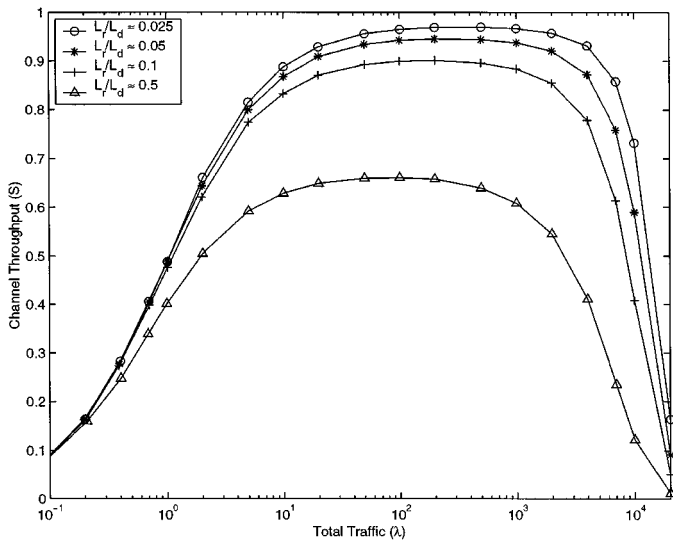

Fig. 10. Performance of different length of control packet.

packet. The length of the data packet is 4096 b and the channel data rate is 1 Mb/s. There are 20 nodes randomly distributed in a  $50 \times 50 \text{ m}^2$  area. The radio transmission range is 35 m, with a maximum propagation delay of  $0.12 \mu\text{s}$ .

As expected, channel throughput decreases with the increase of  $L_r/L_d$ . The channel throughput of the DBTMA scheme is 0.96 when  $L_r/L_d$  is 0.025 ( $L_r = 100$  b). This value decreases to 0.94 as  $L_r/L_d$  increases to 0.05 ( $L_r = 200$  b). When  $L_r/L_d$  is 0.5 ( $L_r = 2000$  b), the throughput is 0.66. The explanation is that the transmission time of the RTS packet contributes to the duration of the failed busy periods and to the overhead of the successful busy periods. When  $L_r$  is larger, the overhead is larger and the throughput is lower.

Finally, in Fig. 11, we compare mean packet delay performance of DBTMA, RI-BTMA, FAMA-NCS, and MACA in an ad hoc network with coverage area of  $400 \times 400 \text{ m}^2$  and radio transmission range of 100 m, with maximum propagation delay as  $0.33 \mu\text{s}$ . Fifty nodes are randomly distributed in the network. The RTS packet length is 200 b, the data packet length is 4096 b, and the channel data rate is 1 Mb/s. In order to compare the packet delay performance of these protocols, we implemented a simple binary exponential back-off (BEB) scheme to allow the blocked and collided data packets to be retransmitted. We also assumed instant acknowledgment of the data packet reception for MACA, since the other schemes guarantee collision-free data packet receptions. The packet arrival at each node is Poisson distributed and each node randomly selects a neighbor as the destination of each packet. The *modified DBTMA* scheme is the DBTMA scheme without the use of  $BT_t$  signal. We defer the discussion of this scheme to the end of the section.

From the graph, it can be observed that the MACA protocol with basic RTS/CTS dialogue and back-off scheme can offer network capacity of 2.2 in the simulated network. The FAMA-NCS scheme (with back-off) is able to carry maximal throughput of 2.4. The RI-BTMA scheme performs better

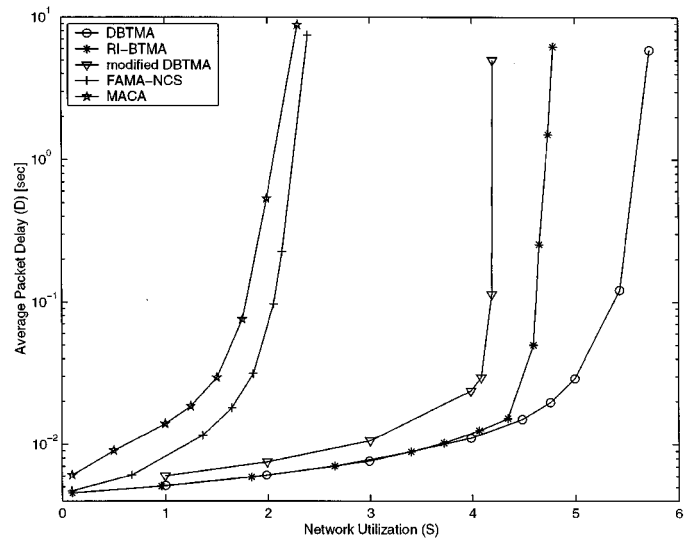

Fig. 11. Network utilization of DBTMA in multi-hop networks.

than both of these schemes, with network capacity of 4.8. The maximal network utilization of the DBTMA scheme is about 5.7, which is 20% higher than that of RI-BTMA and 140% higher than that of FAMA-NCS. Note that these schemes were able to achieve network utilization higher than 1 because of the concurrent transmissions within the network's coverage area.

The explanation of the low performance of MACA is that it solves neither the hidden-terminal problem nor the exposed-terminal problem. The FAMA-NCS scheme has a similar low performance, because it does not solve the exposed-terminal problem. Data packet transmission from the exposed terminals are effectively forbidden on the single channel. The hidden terminals cannot initiate data packet reception, either. FAMA-NCS performs close to MACA in ad hoc networks, although it implements the carrier sensing and the "CTS dominance" mechanisms to support collision-free data packet transmissions. The problem, again, comes from the false "CTS dominance." Note that MACA has almost the same performance as FAMA-NCS does, because we have assumed instant acknowledgment for the MACA scheme in these simulations. As upper layer retransmissions may take place more frequently, we expect the performance of MACA in a real network to be worse than what is shown here.

Both of the DBTMA and the RI-BTMA schemes solve the hidden- and the exposed-terminal problems. RI-BTMA uses slotted operation, requiring time synchronization. DBTMA provides extra protection for the RTS packets, increasing the probability of successful RTS reception at the intended receiver and, thus, increased throughput. For comparison purpose, we also simulated a modified DBTMA scheme, in which no  $BT_t$  signal is used. So the modified DBTMA scheme is an unslotted version of the RI-BTMA scheme. It has a utilization of 4.2. So RI-BTMA, with the help of the slotted operation, increases the performance by 15% over the modified DBTMA scheme. The DBTMA scheme, with the help of the extra busy tone ( $BT_t$ ), gains 35% performance over the modified DBTMA scheme, demonstrating the effectiveness of the second busy tone.



## VI. SUMMARY AND CONCLUDING REMARKS

In communication networks with a shared channel, MAC protocols synchronize access of multiple nodes to the channel. Due to the random access from nodes, packet collisions are difficult to eliminate totally. Communication networks with hidden terminals pose additional challenges to MAC protocols, because of the lack of the knowledge of the on-going communications at these terminals when traditional carrier sensing is used. In order to protect transmission of the data packets, continuous notification of channel state may be used to announce the channel status to all nodes in the range of the node in question.

As the carrier sensing schemes evaluate the state of the channel at the transmitter only, rather than at the receiver, some researchers have proposed to rely on a reservation dialogue (the RTS/CTS dialogue) among the communication nodes. However, some of these schemes, e.g., MACA and MACAW, solves neither the hidden- nor the exposed-terminal problems. FAMA-NCS, with the help of the carrier sensing mechanism, addressed the hidden-terminal problem successful, but left the exposed-terminal problem unsolved. The use of the in-band CTS packet effectively inhibits the data transmission of the exposed terminals and the data reception of the hidden terminals. Furthermore, as there is still the possibility of CTS packet collisions at the neighbor nodes, collisions of data packets are inevitable, unless additional mechanisms are provided to protect them (such as the ones used in FAMA-NCS).

In this paper, we have presented the DBTMA protocol and we have analyzed its performance under various network conditions. In the proposed DBTMA scheme, in addition to the use of the RTS request, two out-of-band busy tones are used. One busy tone, generated at the receiver, serves two functions: 1) notifying the RTS sender that the channel has been successfully acquired and 2) announcing to its neighbor nodes that it is receiving data packet and that they should refrain from accessing the channel. The other busy tone, generated at the transmitter while it is sending the RTS packet, provides protection for the RTS packet. With this design, exposed terminals are able to initiate new transmission, because they do not need to listen to the shared channel to receive the acknowledgment from their intended receivers. Instead, the acknowledgment of the successful channel request will be sent by means of the receive busy tone. Furthermore, the hidden terminals can reply to RTS requests by simply setting up its receive busy tone. When RTS/CTS dialogues are used on the single channel, such as in the MACA, MACAW, and FAMA-NCS schemes, the hidden terminals cannot send their replies. Our analytical and simulation results show that the DBTMA protocol is superior to other schemes that rely on RTS/CTS dialogues on a single channel or those that rely on a single busy tone.

Of course, extra hardware is required by the DBTMA scheme. Two busy tone transmitters and sensing circuits need to be incorporated into each communication node. In our study, we did not consider the bandwidth consumption of the busy tones, which, practically, may not be negligible. However, we have shown that, with the help of these busy tones, the DBTMA scheme can achieve performance gain as high as 140% over MACA and FAMA-NCS. We believe that this performance gain is high enough to offset the bandwidth consumption of the two

busy tones. The performance gain of the DBTMA scheme over the RI-BTMA scheme is about 20%, with the help of an extra busy tone and without the requirement of precise global time synchronization.

We believe that the gain of the DBTMA scheme shown here is a good incentive to incorporate the required hardware at the network nodes. Similar argument is also discussed in the work by Gummalla and Limb [13] for high speed distributed wireless LAN. The novel wireless transceiver architecture proposed and studied in [13] can also be used for the DBTMA scheme to set up the busy tones with small hardware cost.

In our protocol, we have assumed that the interference between busy tone signals and data signal is negligible. This might not be the case in practical network implementations. Careful hardware design may help to minimize the effect of possible interference. Some modifications of the DBTMA protocol might be helpful here as well.

## APPENDIX I DBTMA OPERATION RULES

### A. Variable Definitions

- $\delta$ : data packet transmission time;
- $\tau$ : maximum one way propagation delay;
- $t_d$ : busy tone detection delay;
- $t_{wm}$ : mandatory waiting time ( $t_{wm} = 2\tau$ );
- $BI$ : backoff interval.<sup>7</sup>

### B. Communication Rules

- **(Initialization)** Upon powering up, a node goes into the IDLE state. We assume that both the transmitter ( $\mathcal{A}$ ) and the receiver ( $\mathcal{B}$ ) are in the IDLE state before the transmission.
- **(Send RTS)** When  $\mathcal{A}$  receives a data packet for transmission to the destination  $\mathcal{B}$ , it tries to sense the  $BT_r$  and the  $BT_t$  signals. If no busy tone signal is sensed, it turns on its  $BT_t$  signal, sends an RTS packet to  $\mathcal{B}$ , and goes into the S\_RTS state. If  $\mathcal{A}$  senses a busy tone signal, it sets a random timer (chosen from  $[0, BI]$ ) and goes into the CONTENT state.
- **(Wait for  $BT_r$ )** At the end of the RTS transmission,  $\mathcal{A}$  turns off its  $BT_t$  signal, sets a timer to  $(t_d + 2\tau)$  second, and goes into the WF\_BTR state.
- **(Wait for data)** When  $\mathcal{B}$  receives the RTS packet from  $\mathcal{A}$ , it sets up its  $BT_r$  signal, sets a timer to  $(\delta + t_d + 2\tau)$  second, and goes into the WF\_DATA state.
- **(Mandatory wait)** When  $\mathcal{A}$  senses a  $BT_r$  signal in the WF\_BTR state, it sets a timer to  $(t_{wm} = 2\tau)$  second and goes into the WAIT state.
- **(Send data)** Upon the timeout in the WAIT state,  $\mathcal{A}$  transmits the data packet and goes into the S\_DATA state.
- **(End of transmission)** At the end of the DATA transmission,  $\mathcal{A}$  goes into the IDLE state.
- **(Receive data)** When the data packet arrives or timeout takes place in the WF\_DATA state,  $\mathcal{B}$  sets off the  $BT_r$  signal and goes into the IDLE state.

<sup>7</sup>The backoff interval should be dynamically controlled by a backoff algorithm, such as BEB and MILD. For simplicity, one may use  $10\gamma$  as the  $BI$  value, as suggested by Fullmer and Garcia-Luna-Aceves in [11].

- **(Contend)** Upon timeout in the CONTENTEND state,  $\mathcal{A}$  tries to sense the  $BT_r$  and the  $BT_t$  signals again. If no busy tone signal is sensed, it turns on its  $BT_t$  signal, sends an RTS packet to  $\mathcal{B}$ , and goes into the S\_RTS state. If  $\mathcal{A}$  senses a busy tone signal, it goes back into the IDLE state.
- **(Timeout)** Upon timeout in the WF\_BTR state,  $\mathcal{A}$  goes into the IDLE state.

### C. Defer Rules

- **(Abort RTS)** When a node senses the  $BT_r$  signal during the transmission of its RTS packet, it turns off its  $BT_t$  signal, aborts the transmission, and goes into the IDLE state.

## APPENDIX II

### PROOF OF COLLISION-FREE DATA PACKET RECEPTION

In Section IV, we claimed that with the help of the  $BT_r$  signal and the mandatory waiting time ( $t_{mw}$ ), when the RTS packet is successfully received and the  $BT_r$  signal is set up, data packet reception will be guaranteed. Hence, the DBTMA scheme guarantees collision-free data packet reception. While the claim is made for a fully connected network, we will prove it in regular ad hoc networks.

*Lemma 1:* No RTS packets would collide with data packet reception at the receiver.

*Proof:* Suppose the receiver (node B) receives the RTS packet correctly at time  $t_0$ . At time  $t_0$ , it sets up its  $BT_r$  signal. Since every neighbor of the receiver is at most  $\tau$  seconds away, the  $BT_r$  signal will reach all neighbors at time  $t_1 = t_0 + \tau$ . They will be able to detect the busy tone at time  $t_2 = t_1 + t_d = t_0 + \tau + t_d$ . So no RTS packets will be sent after  $t_2$  in the range of the receiver.

Hence the receiver can be sure that all RTS transmissions will be cleared as of  $t_3 = t_2 + \tau = t_0 + 2\tau + t_d$ .

The earliest time the sender (node A) senses the  $BT_r$  signal from the receiver is  $t_4 = t_0 + t_d$ . Because of the mandatory waiting time ( $t_{mw}$ ), its data packet transmission will not start until  $t_5 = t_4 + t_{mw} = t_0 + t_d + t_{mw}$ , which is the earliest time the beginning edge of the data packet arrives at node B.

Thus, we can be sure that the data packet is free from RTS collisions if  $t_5 \geq t_3$  is satisfied, which is ensured by our assumption that  $t_{mw} = 2\tau$ . Q.E.D.

*Lemma 2:* No other data packets will collide with data packet reception at the receiver.

*Proof:* Suppose there is a node (node C, which is in the range of the receiver node B)  $\tau'$  second away from node B. Since node B gets the RTS packet successfully at time  $t_0$ , node C must have not been sending any packet in  $[t_0 - \gamma - \tau', t_0 - \tau']$ . Otherwise, the transmission from node C would have collided the incoming RTS packet at node B.

Since node C has been silent for a period of time, the only possibility of its data packet transmission would be that it has sent its RTS packet to another node already and is waiting for its busy tone reply in the idle period. We now prove that this is impossible: The latest time for node C to finish its RTS transmission is  $t_6 = t_0 - \gamma - \tau'$ . Hence the latest time for node C to

start sending its data packet would be  $t_7 = t_6 + \tau + t_d + \tau + t_{mw}$ , where we have assumed node C's intended receiver is  $\tau$  second away. Recall that  $\gamma \geq t_d + 4\tau$

$$\begin{aligned} t_7 &= t_6 + \tau + t_d + \tau + t_{mw} \\ &= t_0 - \tau' - \gamma + t_d + 4\tau \\ &\leq t_0 - \tau' - (t_d + 4\tau) + t_d + 4\tau \\ &= t_0 - \tau'. \end{aligned} \quad (9)$$

This is contradictory to the fact that node C was not sending any packet in  $[t_0 - \gamma - \tau', t_0 - \tau']$ . Q.E.D.

*Theorem:* When an RTS packet is received correctly and  $BT_r$  set up by the receiver, collision-free data packet reception is guaranteed.

*Proof:* This is proved by Lemmas 1 and 2. Since neither an RTS packet nor a data packet would collide with the data packet at the receiver, the data packet is free from collisions. Q.E.D.

## ACKNOWLEDGMENT

The authors would like to thank three anonymous reviewers and the editor, the Prof. Y. Fang, for their valuable comments and suggestions for improvement of the paper.

## REFERENCES

- [1] J. C. Haartsen, "The Bluetooth radio system," *IEEE Personal Commun.*, vol. 7, pp. 28–36, Feb. 2000.
- [2] Specification of the Bluetooth System [Online]. Available: <http://www.bluetooth.com/developer/specification/specification.asp>
- [3] L. Kleinrock and F. A. Tobagi, "Packet switching in radio channels: Part I—Carrier sensing multiple-access modes and their throughput–delay characteristics," *IEEE Trans. Commun.*, vol. COM-23, pp. 1400–1416, Dec. 1975.
- [4] A. Colvin, "CSMA with collision avoidance," *Computer Commun.*, vol. 6, no. 5, pp. 227–235, Oct. 1983.
- [5] P. Karn, "MACA—A new channel access method for packet radio," in *ARRL/CRRL Amateur Radio 9th Computer Networking Conf.*, 1990, pp. 134–140.
- [6] F. A. Tobagi and L. Kleinrock, "Packet switching in radio channels: Part II—The hidden terminal problem in carrier sense multiple-access and the busy-tone solution," *IEEE Trans. Commun.*, vol. COM-23, pp. 1417–1433, Dec. 1975.
- [7] V. Bharghavan, A. Demers, S. Shenker, and L. Zhang, "MACAW: A media access protocol for wireless LAN's," in *Proc. ACM SIGCOMM '94*, 1994, pp. 212–225.
- [8] F. A. Tobagi and L. Kleinrock, "Packet switching in radio channels: Part III—Polling and (dynamic) split-channel reservation multiple access," *IEEE Trans. Commun.*, vol. COM-24, pp. 832–844, Aug. 1976.
- [9] C. Wu and V. O. K. Li, "Receiver-initiated busy-tone multiple access in packet radio networks," in *Proc. ACM SIGCOMM '87*, 1987, pp. 336–342.
- [10] C. L. Fullmer and J. J. Garcia-Luna-Aceves, "Floor acquisition multiple access (FAMA) for packet-radio networks," in *Proc. ACM SIGCOMM '95*, 1995, pp. 262–273.
- [11] —, "Solutions to hidden terminal problems in wireless networks," in *Proc. ACM SIGCOMM '97*, 1997, pp. 39–49.
- [12] *Wireless LAN MAC and Physical Layer Specifications*, IEEE 802.11, June 1997.
- [13] A. C. V. Gummalla and J. O. Limb, "Design of an access mechanism for a high speed distributed wireless LAN," *IEEE J. Select. Areas Commun.*, vol. 18, Sept. 2000.
- [14] H. Takagi and L. Kleinrock, "Output processes in contention packet broadcasting systems," *IEEE Trans. Commun.*, vol. COM-33, pp. 1191–1199, Nov. 1985.



**Zygmunt J. Haas** (S'84–M'88–SM'90) received the B.Sc. and M.Sc. degrees in electrical engineering in 1979 and 1985, respectively, and the Ph.D. degree from Stanford University, Stanford, CA, in 1988.

He subsequently joined AT&T Bell Laboratories in the Network Research Department. There he pursued research on wireless communications, mobility management, fast protocols, optical networks, and optical switching. From September 1994 until July 1995, he worked for the AT&T Wireless Center of Excellence, where he investigated various aspects of wireless and

mobile networking, concentrating on TCP/IP networks. As of August 1995, he joined the faculty of the School of Electrical and Computer Engineering at Cornell University, Ithaca, NY. He is the author of numerous technical papers and holds 14 patents in the fields of high-speed networking, wireless networks, and optical switching. His interests include: mobile and wireless communication and networks, personal communication service, and high-speed communication and protocols. He has organized several Workshops and delivered tutorials at major IEEE and ACM Conferences.

Dr. Haas is a voting member of ACM and a Chair of the IEEE Technical Committee on Personal Communications. He serves as Editor of several journals and magazines, including the IEEE TRANSACTIONS ON NETWORKING. He has been a Guest Editor of three issues of the IEEE JOURNAL ON SELECTED AREAS OF COMMUNICATION (*Gigabit Networks*, *Mobile Computing Networks*, and *Ad Hoc Networks*).



**Jing Deng** (S'97) received the B.E. and M.E. degrees in electrical engineering from Tsinghua University, Beijing, P. R. China, in 1994 and 1997, respectively, and the Ph.D. degree from Cornell University, Ithaca, NY, in 2002.

His interests include protocol design, evaluation, and optimization for mobile *ad hoc* networks.