



Section 3. Memory Organization

HIGHLIGHTS

This section of the manual contains the following topics:

3.1	Introduction.....	3-2
3.2	Control Registers.....	3-2
3.3	Memory Layout.....	3-12
3.4	Address Map.....	3-14
3.5	Bus Matrix.....	3-27
3.6	I/O Pin Control.....	3-31
3.7	Operation in Power-Saving and Debug Modes.....	3-31
3.8	Code Examples.....	3-31
3.9	Related Application Notes.....	3-32
3.10	Revision History.....	3-33

Note: This family reference manual section is meant to serve as a complement to device data sheets. Depending on the device variant, this manual section may not apply to all PIC32 devices.

Please consult the note at the beginning of the “**Memory Organization**” chapter in the current device data sheet to check whether this document supports the device you are using.

Device data sheets and family reference manual sections are available for download from the Microchip Worldwide Web site at: <http://www.microchip.com>

3.1 INTRODUCTION

The PIC32 microcontrollers provide 4 GB of unified virtual memory address space. All memory regions, including program memory, data memory, SFRs and Configuration registers reside in this address space at their respective unique addresses. The program and data memories can be optionally partitioned into user and kernel memories. In addition, the data memory can be made executable, allowing the PIC32 to execute from data memory.

Key features of PIC32 memory organization include the following:

- 32-bit native data width
- Separate User and Kernel mode address spaces
- Flexible program Flash memory partitioning
- Flexible data RAM partitioning for data and program space
- Separate boot Flash memory for protected code
- Robust bus-exception handling to intercept runaway code
- Simple memory mapping with Fixed Mapping Translation (FMT) unit
- Cacheable and non-cacheable address regions

3.2 CONTROL REGISTERS

This section lists the Special Function Registers (SFRs) used for setting the RAM and Flash memory partitions for data and code (for both User and Kernel mode).

- **BMXCON: Bus Matrix Configuration Register**

This register configures program Flash cacheability for DMA accesses, bus error exceptions, data RAM wait states and arbitration modes.

- **BMXDKPBA: Data RAM Kernel Program Base Address Register**,
BMXDUDBA: Data RAM User Data Base Address Register,
BMXDUPBA: Data RAM User Program Base Address Register, and
BMXPUPBA: Program Flash Memory User Program Base Address Register

These registers identify relative base addresses for kernel, User mode data and User mode program space in RAM.

- **BMXDRMSZ: Data RAM Size Register**

This read-only register identifies the size of the Data RAM in bytes.

- **BMXPFMSZ: Program Flash Memory Size Register**

This read-only register identifies the size of the Program Flash Memory in bytes.

- **BMXDRMSZ: Data RAM Size Register**

This read-only register identifies the size of the Boot Program Flash Memory in bytes.

Table 3-1 provides a brief summary of all related Memory organization registers. Corresponding register tables appear after the summary, which include detailed description of each register bit.

Table 3-1: Memory Organization SFR Summary

Name	Bit Range	Bit 31/15	Bit 30/14	Bit 29/13	Bit 28/12	Bit 27/11	Bit 26/10	Bit 25/9	Bit 24/8	Bit 23/7	Bit 22/6	Bit 21/5	Bit 20/4	Bit 19/3	Bit 118/2	Bit 17/1	Bit 16/0
BMXCON ⁽¹⁾	31:16	—	—	—	—	—	BMX CHEDMA	—	—	—	—	—	BMX ERRIXI	BMX ERRICD	BMX ERRDMA	BMX ERRDS	BMX ERRIS
	15:0	—	—	—	—	—	—	—	—	—	BMX WSDRM	—	—	—	BMXARB<2:0>		
BMXDKPBA ⁽¹⁾	31:16	—	—	—	—	—	—	—	—	—	—	—	—	—	—	—	BMX DKPBA<16>
	15:0	BMXDKPBA<15:0>															
BMXDUDBA ⁽¹⁾	31:16	—	—	—	—	—	—	—	—	—	—	—	—	—	—	—	BMX DUDBA<16>
	15:0	BMXDUDBA<15:0>															
BMXDUPBA ⁽¹⁾	31:16	—	—	—	—	—	—	—	—	—	—	—	—	—	—	—	BMX DUPBA<16>
	15:0	BMXDUPBA<15:0>															
BMXDRMSZ	31:16	BMXDRMSZ<31:16>															
	15:0	BMXDRMSZ<15:0>															
BMXPUPBA ⁽¹⁾	31:16	—	—	—	—	—	—	—	—	—	—	—	—	BMXPUPBA<19:16>			
	15:0	BMXPUPBA<15:0>															
BMXPFMSZ	31:16	BMXPFMSZ<31:16>															
	15:0	BMXPFMSZ<16:0>															
BMXBOOTSZ	31:16	BMXBOOTSZ<31:16>															
	15:0	BMXBOOTSZ<15:0>															

Legend: — = unimplemented, read as '0'. Address offset values are shown in hexadecimal.

Note 1: This register has an associated Clear, Set, and Invert register at an offset of 0x4, 0x8, and 0xC bytes, respectively. These registers have the same name with CLR, SET, or INV appended to the end of the register name (e.g., BMXCONCLR). Writing a '1' to any bit position in these registers will clear, set, or invert valid bits in the associated register. Reads from these registers should be ignored.

PIC32 Family Reference Manual

Register 3-1: BMXCON: Bus Matrix Configuration Register

Bit Range	Bit 31/23/15/7	Bit 30/22/14/6	Bit 29/21/13/5	Bit 28/20/12/4	Bit 27/19/11/3	Bit 26/18/10/2	Bit 25/17/9/1	Bit 24/16/8/0
31:24	U-0	U-0	U-0	U-0	U-0	R/W-0	U-0	U-0
	—	—	—	—	—	BMXCHEDMA ⁽¹⁾	—	—
23:16	U-0	U-0	U-0	R/W-1	R/W-1	R/W-1	R/W-1	R/W-1
	—	—	—	BMXERRIXI	BMXERRICD	BMXERRDMA	BMXERRDS	BMXERRIS
15:8	U-0	U-0	U-0	U-0	U-0	U-0	U-0	U-0
	—	—	—	—	—	—	—	—
7:0	U-0	R/W-1	U-0	U-0	U-0	R/W-0	R/W-0	R/W-1
	—	BMXWSDRM	—	—	—	BMXARB<2:0>		

Legend:

R = Readable bit	W = Writable bit	U = Unimplemented bit, read as '0'
-n = Value at POR	'1' = Bit is set	'0' = Bit is cleared x = Bit is unknown

bit 31-27 **Unimplemented:** Read as '0'

bit 26 **BMXCHEDMA:** BMX PFM Cacheability for DMA Accesses bit⁽¹⁾
 1 = Enable program Flash memory (data) cacheability for DMA accesses (requires cache to have data caching enabled)
 0 = Disable program Flash memory (data) cacheability for DMA accesses (hits are still read from the cache, but misses do not update the cache)

bit 25-21 **Unimplemented:** Read as '0'

bit 20 **BMXERRIXI:** Enable Bus Error from IXI bit
 1 = Enable bus error exceptions for unmapped address accesses initiated from IXI shared bus
 0 = Disable bus error exceptions for unmapped address accesses initiated from IXI shared bus

bit 19 **BMXERRICD:** Enable Bus Error from ICD Debug Unit bit
 1 = Enable bus error exceptions for unmapped address accesses initiated from ICD
 0 = Disable bus error exceptions for unmapped address accesses initiated from ICD

bit 18 **BMXERRDMA:** Bus Error from DMA bit
 1 = Enable bus error exceptions for unmapped address accesses initiated from DMA
 0 = Disable bus error exceptions for unmapped address accesses initiated from DMA

bit 17 **BMXERRDS:** Bus Error from CPU Data Access bit (disabled in Debug mode)
 1 = Enable bus error exceptions for unmapped address accesses initiated from CPU data access
 0 = Disable bus error exceptions for unmapped address accesses initiated from CPU data access

bit 16 **BMXERRIS:** Bus Error from CPU Instruction Access bit (disabled in Debug mode)
 1 = Enable bus error exceptions for unmapped address accesses initiated from CPU instruction access
 0 = Disable bus error exceptions for unmapped address accesses initiated from CPU instruction access

bit 15-7 **Unimplemented:** Read as '0'

bit 6 **BMXWSDRM:** CPU Instruction or Data Access from Data RAM Wait State bit
 1 = Data RAM accesses from CPU have one wait state for address setup
 0 = Data RAM accesses from CPU have zero wait states for address setup

bit 5-3 **Unimplemented:** Read as '0'

Note 1: This bit is not available on all devices. Refer to the “Memory Organization” chapter in the specific device data sheet to determine availability.

Register 3-1: BMXCON: Bus Matrix Configuration Register (Continued)

bit 2-0 **BMXARB<2:0>**: Bus Matrix Arbitration Mode bits

111 = Reserved; do not use. Using these Configuration modes will produce undefined behavior

•
•
•

011 = Reserved; do not use. Using these Configuration modes will produce undefined behavior.

010 = Arbitration Mode 2

001 = Arbitration Mode 1 (default)

000 = Arbitration Mode 0

Note 1: This bit is not available on all devices. Refer to the “**Memory Organization**” chapter in the specific device data sheet to determine availability.

PIC32 Family Reference Manual

Register 3-2: BMXDKPBA: Data RAM Kernel Program Base Address Register

Bit Range	Bit 31/23/15/7	Bit 30/22/14/6	Bit 29/21/13/5	Bit 28/20/12/4	Bit 27/19/11/3	Bit 26/18/10/2	Bit 25/17/9/1	Bit 24/16/8/0
31:24	U-0	U-0	U-0	U-0	U-0	U-0	U-0	U-0
	—	—	—	—	—	—	—	—
23:16	U-0	U-0	U-0	U-0	U-0	U-0	U-0	R/W-0
	—	—	—	—	—	—	—	BMX DKPBA<16>
15:8	R/W-0	R/W-0	R/W-0	R/W-0	R/W-0	R/W-0	R-0	R-0
	BMXDKPBA<15:8>							
7:0	R-0	R-0	R-0	R-0	R-0	R-0	R-0	R-0
	BMXDKPBA<7:0>							

Legend:

R = Readable bit	W = Writable bit	U = Unimplemented bit, read as '0'
-n = Value at POR	'1' = Bit is set	'0' = Bit is cleared x = Bit is unknown

bit 31-17 **Unimplemented:** Read as '0'

bit 16-10 **BMXDKPBA<16:10>:** DRM Kernel Program Base Address bits

When non-zero, this value selects the relative base address for kernel program space in RAM

bit 9-0 **BMXDKPBA<9:0>:** Read-Only bits

Value is always '0', which forces 1 KB increments.

Note 1: At Reset, the value in this register is forced to zero, which causes all of the RAM to be allocated to Kernel mode data usage.

2: The value in this register must be less than or equal to BMXDRMSZ.

Section 3. Memory Organization

Register 3-3: BMXDUDBA: Data RAM User Data Base Address Register

Bit Range	Bit 31/23/15/7	Bit 30/22/14/6	Bit 29/21/13/5	Bit 28/20/12/4	Bit 27/19/11/3	Bit 26/18/10/2	Bit 25/17/9/1	Bit 24/16/8/0
31:24	U-0	U-0	U-0	U-0	U-0	U-0	U-0	U-0
	—	—	—	—	—	—	—	—
23:16	U-0	U-0	U-0	U-0	U-0	U-0	U-0	R/W-0
	—	—	—	—	—	—	—	BMX DUDBA<16>
15:8	R/W-0	R/W-0	R/W-0	R/W-0	R/W-0	R/W-0	R-0	R-0
	BMXDUDBA<15:8>							
7:0	R-0	R-0	R-0	R-0	R-0	R-0	R-0	R-0
	BMXDUDBA<7:0>							

Legend:

R = Readable bit	W = Writable bit	U = Unimplemented bit, read as '0'
-n = Value at POR	'1' = Bit is set	'0' = Bit is cleared x = Bit is unknown

bit 31-17 **Unimplemented:** Read as '0'

bit 16-10 **BMXDUDBA<16:10>:** DRM User Data Base Address bits

When non-zero, the value selects the relative base address for User mode data space in RAM. If non-zero, the value must be greater than BMXDKPBA.

bit 9-0 **BMXDUDBA<9:0>:** Read-only bits

Value is always '0', which forces 1 KB increments.

Note 1: At Reset, the value in this register is forced to zero, which causes all of the RAM to be allocated to Kernel mode data usage.

2: The value in this register must be less than or equal to BMXDRMSZ.

PIC32 Family Reference Manual

Register 3-4: BMXDUPBA: Data RAM User Program Base Address Register

Bit Range	Bit 31/23/15/7	Bit 30/22/14/6	Bit 29/21/13/5	Bit 28/20/12/4	Bit 27/19/11/3	Bit 26/18/10/2	Bit 25/17/9/1	Bit 24/16/8/0
31:24	U-0	U-0	U-0	U-0	U-0	U-0	U-0	U-0
	—	—	—	—	—	—	—	—
23:16	U-0	U-0	U-0	U-0	U-0	U-0	U-0	R/W-0
	—	—	—	—	—	—	—	BMX DUPBA<16>
15:8	R/W-0	R/W-0	R/W-0	R/W-0	R/W-0	R/W-0	R-0	R-0
	BMXDUPBA<15:8>							
7:0	R-0	R-0	R-0	R-0	R-0	R-0	R-0	R-0
	BMXDUPBA<7:0>							

Legend:

R = Readable bit W = Writable bit U = Unimplemented bit, read as '0'
 -n = Value at POR '1' = Bit is set '0' = Bit is cleared x = Bit is unknown

bit 31-17 **Unimplemented:** Read as '0'

bit 16-10 **BMXDUPBA<16:10>:** DRM User Program Base Address bits

When non-zero, the value selects the relative base address for User mode program space in RAM. If non-zero, BMXDUPBA must be greater than BMXDUDBA.

bit 9-0 **BMXDUPBA<9:0>:** Read-only bits

Value is always '0', which forces 1 KB increments.

Note 1: At Reset, the value in this register is forced to zero, which causes all of the RAM to be allocated to Kernel mode data usage.

2: The value in this register must be less than or equal to BMXDRMSZ.

Section 3. Memory Organization

Register 3-5: BMXDRMSZ: Data RAM Size Register

Bit Range	Bit 31/23/15/7	Bit 30/22/14/6	Bit 29/21/13/5	Bit 28/20/12/4	Bit 27/19/11/3	Bit 26/18/10/2	Bit 25/17/9/1	Bit 24/16/8/0
31:24	R	R	R	R	R	R	R	R
BMXDRMSZ<31:24>								
23:16	R	R	R	R	R	R	R	R
BMXDRMSZ<23:16>								
15:8	R	R	R	R	R	R	R	R
BMXDRMSZ<15:8>								
7:0	R	R	R	R	R	R	R	R
BMXDRMSZ<7:0>								

Legend:

R = Readable bit	W = Writable bit	U = Unimplemented bit, read as '0'
-n = Value at POR	'1' = Bit is set	'0' = Bit is cleared x = Bit is unknown

bit 31-0 **BMXDRMSZ<31:0>**: Data RAM Memory (DRM) Size bits

Static value that indicates the size of the Data RAM in bytes:

- 0x00002000 = device has 8 KB RAM
- 0x00004000 = device has 16 KB RAM
- 0x00008000 = device has 32 KB RAM
- 0x00010000 = device has 64 KB RAM
- 0x00020000 = device has 128 KB RAM

PIC32 Family Reference Manual

Register 3-6: BMXPUPBA: Program Flash Memory User Program Base Address Register

Bit Range	Bit 31/23/15/7	Bit 30/22/14/6	Bit 29/21/13/5	Bit 28/20/12/4	Bit 27/19/11/3	Bit 26/18/10/2	Bit 25/17/9/1	Bit 24/16/8/0
31:24	U-0	U-0	U-0	U-0	U-0	U-0	U-0	U-0
	—	—	—	—	—	—	—	—
23:16	U-0	U-0	U-0	U-0	R/W-0	R/W-0	R/W-0	R/W-0
	—	—	—	—	BMXPUPBA<19:16>			
15:8	R/W-0	R/W-0	R/W-0	R/W-0	R/W-0	R-0	R-0	R-0
	BMXPUPBA<15:8>							
7:0	R-0	R-0	R-0	R-0	R-0	R-0	R-0	R-0
	BMXPUPBA<7:0>							

Legend:

R = Readable bit W = Writable bit U = Unimplemented bit, read as '0'
 -n = Value at POR '1' = Bit is set '0' = Bit is cleared x = Bit is unknown

bit 31-20 **Unimplemented:** Read as '0'
 bit 19-11 **BMXPUPBA<19:11>**: Program Flash User Program Base Address bits
 bit 10-0 **BMXPUPBA<10:0>**: Read-only bits
 Value is always '0', which forces 2 KB increments.

Note 1: At Reset, the value in this register is forced to zero, which causes all of the RAM to be allocated to Kernel mode program usage.
2: The value in this register must be less than or equal to BMXPFMSZ.

Register 3-7: BMXPFMSZ: Program Flash Memory Size Register

Bit Range	Bit 31/23/15/7	Bit 30/22/14/6	Bit 29/21/13/5	Bit 28/20/12/4	Bit 27/19/11/3	Bit 26/18/10/2	Bit 25/17/9/1	Bit 24/16/8/0
31:24	R	R	R	R	R	R	R	R
	BMXPFMSZ<31:24>							
23:16	R	R	R	R	R	R	R	R
	BMXPFMSZ<23:16>							
15:8	R	R	R	R	R	R	R	R
	BMXPFMSZ<15:8>							
7:0	R	R	R	R	R	R	R	R
	BMXPFMSZ<7:0>							

Legend:

R = Readable bit W = Writable bit U = Unimplemented bit, read as '0'
 -n = Value at POR '1' = Bit is set '0' = Bit is cleared x = Bit is unknown

bit 31-0 **BMXPFMSZ<31:0>**: Program Flash Memory Size bits
 Static value that indicates the size of the PFM in bytes:
 0x00008000 = device has 32 KB Flash
 0x00010000 = device has 64 KB Flash
 0x00020000 = device has 128 KB Flash
 0x00040000 = device has 256 KB Flash
 0x00080000 = device has 512 KB Flash

Section 3. Memory Organization

Register 3-8: BMXBOOTSZ: Boot Flash (IFM) Size Register

Bit Range	Bit 31/23/15/7	Bit 30/22/14/6	Bit 29/21/13/5	Bit 28/20/12/4	Bit 27/19/11/3	Bit 26/18/10/2	Bit 25/17/9/1	Bit 24/16/8/0
31:24	R	R	R	R	R	R	R	R
	BMXBOOTSZ<31:24>							
23:16	R	R	R	R	R	R	R	R
	BMXBOOTSZ<23:16>							
15:8	R	R	R	R	R	R	R	R
	BMXBOOTSZ<15:8>							
7:0	R	R	R	R	R	R	R	R
	BMXBOOTSZ<7:0>							

Legend:

R = Readable bit	W = Writable bit	U = Unimplemented bit, read as '0'
-n = Value at POR	'1' = Bit is set	'0' = Bit is cleared x = Bit is unknown

bit 31-0 **BMXBOOTSZ<31:0>**: Boot Flash Memory (BFM) Size bits

Static value that indicates the size of the Boot PFM in bytes. Refer to the “**Memory Organization**” chapter in the specific device data sheet for the available bit values.

3.3 MEMORY LAYOUT

The PIC32 microcontrollers implement two address spaces: virtual and physical. All hardware resources, such as program memory, data memory and peripherals, are located at their respective physical addresses. Virtual addresses are exclusively used by the CPU to fetch and execute instructions. Physical addresses are used by peripherals, such as DMA and Flash controllers, that access memory independently of the CPU.

Figure 3-1: Virtual to Physical Fixed Memory Mapping Example

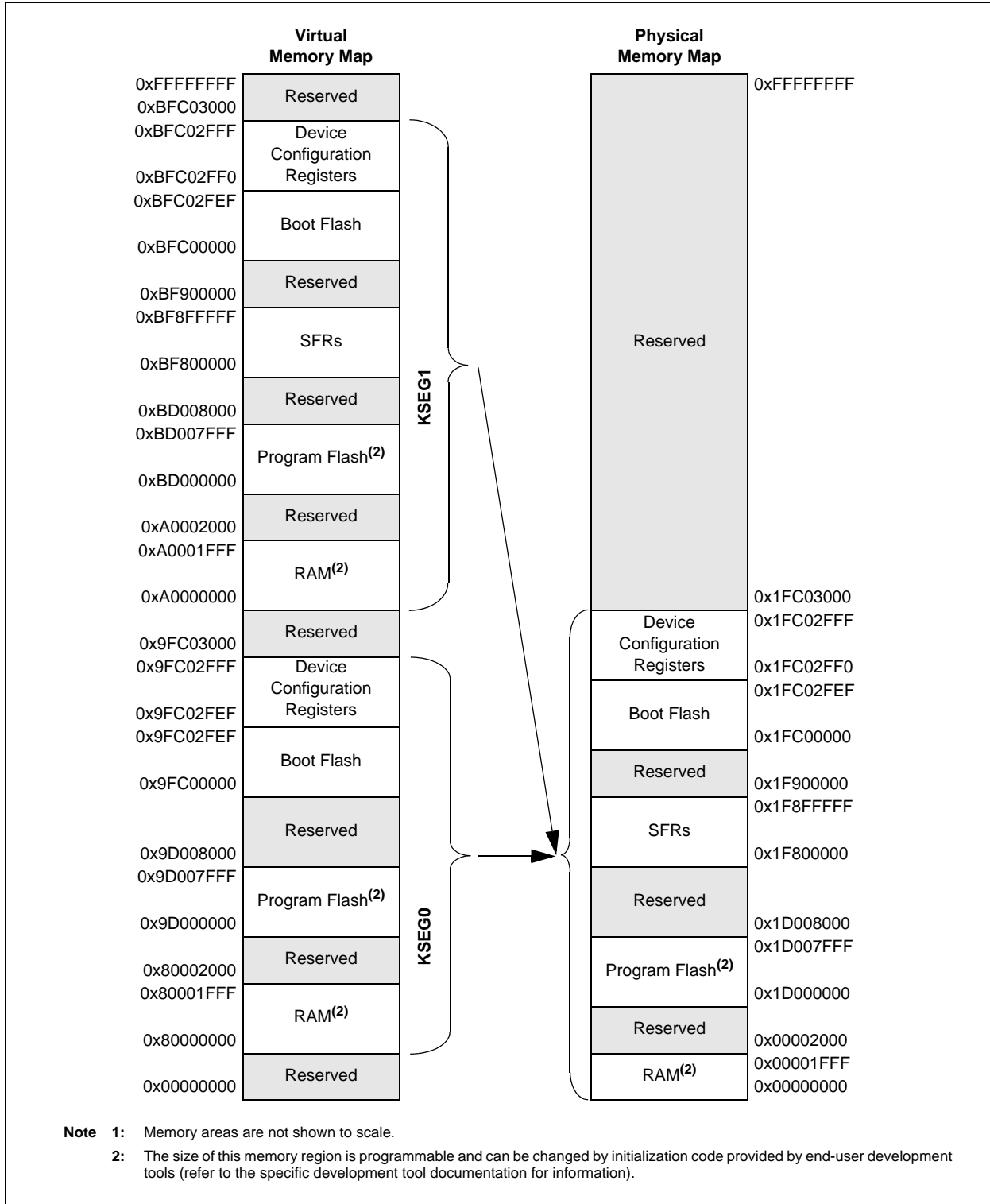

Section 3. Memory Organization

The entire 4 GB virtual address space is divided into two primary regions: user and kernel space. The lower 2 GB of space from the User mode segment is called USEG/KUSEG. A User mode application must reside and execute in the USEG segment. The USEG segment is also available to all Kernel mode applications, which is why it is also named KUSEG – to indicate that it is available to both User and Kernel modes. When operating in User mode, the bus matrix must be configured to make part of the Flash and data memory available in the USEG/KUSEG segment. See [3.4 “Address Map”](#) for more information.

Figure 3-2: User/Kernel Address Segments

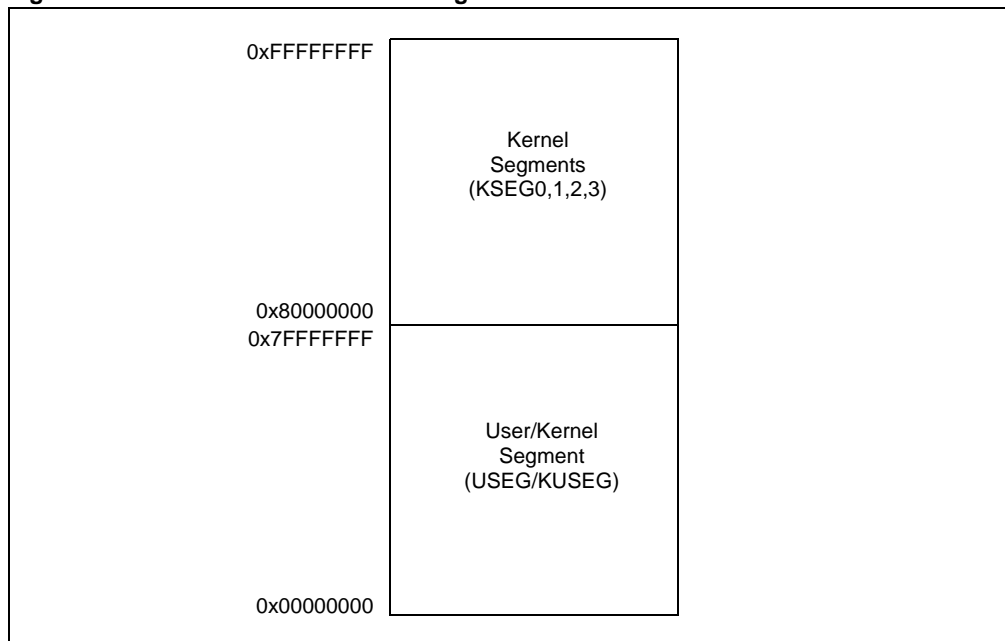

The upper 2 GB of virtual address space forms the kernel only space. The kernel space is divided into four segments of 512 MB each: KSEG0, KSEG1, KSEG2 and KSEG3. Only Kernel mode applications can access kernel space memory. The kernel space includes all peripheral registers. Consequently, only Kernel mode applications can monitor and manipulate peripherals. Only KSEG0 and KSEG1 segments point to real memory resources. Segment KSEG2 is available to the EJTAG probe debugger, as explained in the MIPS documentation (refer to the EJTAG specification). The PIC32 only uses KSEG0 and KSEG1 segments. The Boot Flash Memory (BFM), Program Flash Memory (PFM), Data RAM Memory (DRM) and peripheral SFRs are accessible from either KSEG0 or KSEG1, while the peripheral SFRs are accessible only from KSEG1.

The Fixed Mapping Translation (FMT) unit translates the memory segments into corresponding physical address regions. [Figure 3-1](#) illustrates the fixed mapping scheme implemented by the PIC32 core between the virtual and physical address space. A virtual memory segment may also be cached, provided the cache module is available on the device. The KSEG1 memory segment is not cacheable, while KSEG0 and USEG/KUSEG are cacheable.

The mapping of the memory segments depend on the CPU error level (set by the ERL bit in the CPU Status register). Error Level is set (ERL = 1) by the CPU on a Reset, Soft Reset or NMI. In this mode, the processor runs in Kernel mode and USEG/KUSEG are treated as unmapped and uncached regions, and the mapping in [Figure 3-1](#) does not apply. This mode is provided for compatibility with other MIPS processor cores that use a TLB-based MMU. The C start-up code clears the ERL bit to zero, so that when application software starts up, it sees the proper virtual to physical memory mapping as illustrated in [Figure 3-1](#).

KSEG0 and KSEG1 segments are always translated to physical address 0x0. This translation arrangement allows the CPU to access identical physical addresses from two separate virtual addresses: one from KSEG0 and the other from KSEG1. As a result, the application can choose to execute the same piece of code as either cached or uncached. See [Section 4. “Prefetch Cache Module”](#) (DS61119) for more details. The on-chip peripherals are visible through KSEG1 segment only (uncached access).

3.4 ADDRESS MAP

The Program Flash Memory is divided into kernel and user partitions. The kernel program Flash space starts at physical address 0x1D000000, whereas the user program Flash space starts at physical address 0xBD000000 + BMXPUPBA register value. Similarly, the internal RAM is also divided into kernel and user partitions. The kernel RAM space starts at physical address 0x00000000, whereas the user RAM space starts at physical address 0xBF000000 + BMXDUDBA register value. By default, the full Flash memory and RAM are mapped to Kernel mode application only.

The BMXxxxBA register settings must match the memory model of the target software application. If the linked code does not match the register values, the program may not run and may generate bus error exceptions on start-up.

Note: The Program Flash Memory is not writable through its address map. A write to the PFM address range causes a bus error exception.

3.4.1 Virtual to Physical Address Calculation (and Vice-Versa)

To translate the kernel address (KSEG0 or KSEG1) to a physical address, perform a “Bitwise AND” operation of the virtual address with 0x1FFFFFFF:

- Physical Address = Virtual Address & 0x1FFFFFFF

For physical address to KSEG0 virtual address translation, perform a “Bitwise OR” operation of the physical address with 0x80000000:

- KSEG0 Virtual Address = Physical Address | 0x80000000

For physical address to KSEG1 virtual address translation, perform a “Bitwise OR” operation of the physical address with 0xA0000000:

- KSEG1 Virtual Address = Physical Address | 0xA0000000

To translate from KSEG0 to KSEG1 virtual address, perform a “Bitwise OR” operation of the KSEG0 virtual address with 0x20000000:

- KSEG1 Virtual Address = KSEG0 Virtual Address | 0x20000000

Section 3. Memory Organization

Table 3-2: Address Map

Memory Type	Virtual Addresses		Physical Addresses		Size in Bytes	
	Begin Address	End Address	Begin Address	End Address	Calculation	
Kernel Address Space	Boot Flash	0xBFC00000	0xBFC02FFF	0x1FC00000	0x1FC02FFF	12 KB
	Peripheral	0xBF800000	0xBF8FFFFFF	0x1F800000	0x1F8FFFFFF	4 KB
	KSEG1 Program Flash ^(1,3)	0xBD000000	0xBD000000 + BMXPUPBA - 1	0x1D000000	0x1D000000 + BMXPUPBA - 1	BMXPUPBA
	KSEG1 Program RAM ⁽⁶⁾	0xA0000000 + BMXDKPBA	0xA0000000 + BMXDUDBA - 1	0x00000000 + BMXDKPBA	0x00000000 + BMXDUDBA - 1	BMXDUDBA - BMXDKPBA
	KSEG1 Data RAM ⁽⁶⁾	0xA0000000	0xA0000000 + BMXDKPBA - 1	0x00000000	0x00000000 + BMXDKPBA - 1	BMXPUPBA
	KSEG0 Program Flash ^(2,5)	0x9D000000	0x9D000000 + BMXPUPBA - 1	0x1D000000	0x1D000000 + BMXPUPBA - 1	BMXPUPBA
	KSEG0 Program RAM ⁽⁶⁾	0x80000000 + BMXDKPBA	0x80000000 + BMXDUDBA - 1	0x00000000 + BMXDKPBA	0x00000000 + BMXDUDBA - 1	BMXDUDBA - BMXDKPBA
	KSEG0 Data RAM ⁽⁶⁾	0x80000000	0x80000000 + BMXDKPBA - 1	0x00000000	0x00000000 + BMXDKPBA - 1	BMXDKPBA
Memory Type	Virtual Addresses		Physical Addresses		Size in Bytes	
	Begin Address	End Address	Begin Address	End Address	Calculation	
User Address Space	USEG/KSEG Program RAM ⁽⁶⁾	0x7F000000 + BMXDUPBA	0x7F000000 + BMXDRMSZ - 1 ⁽³⁾	0xBF000000 + BMXDUPBA	0xBF000000 + BMXDRMSZ ⁽³⁾ - 1	BMXDRMSZ ⁽³⁾ - BMXDUPBA
	USEG/KSEG Data RAM ⁽⁶⁾	0x7F000000 + BMXDUDBA	0x7F000000 + BMXDUPBA - 1	0xBF000000 + BMXDUDBA	0xBF000000 + BMXDUPBA - 1	BMXDUPBA - BMXDUDBA
	USEG/KSEG Program Flash ⁽⁶⁾	0x7D000000 + BMXPUPBA	0x7D000000 + BMXPFMSZ ⁽⁴⁾ - 1	0xBD000000 + BMXPUPBA	0xBF000000 + BMXPFMSZ ⁽⁴⁾ - 1	BMXPFMSZ ⁽⁴⁾ - BMXPUPBA

- Note 1:** Program Flash virtual addresses in the non-cacheable range (KSEG1).
- Note 2:** Program Flash virtual addresses in the cacheable and prefetchable range (KSEG0).
- Note 3:** The RAM size varies between PIC32 device variants.
- Note 4:** The Flash size varies between PIC32 device variants.
- Note 5:** When the BMXPUPBA register is equal to '0', all program Flash is allocated to Kernel mode program usage. This is the default state at Reset.
- Note 6:** When the BMXDUDBA, BMXDUPBA, or BMXDKPBA register is equal to '0', all RAM is allocated to Kernel mode data usage. This is the default state at Reset.

3.4.2 Program Flash Memory Partitioning

The Program Flash Memory can be partitioned for User and Kernel mode programs as illustrated in Figure 3-1.

At Reset, the User mode partition does not exist (BMXPUPBA is initialized to '0'). The entire program Flash memory is mapped to Kernel mode program space starting at virtual address KSEG1:0xBD000000 (or KSEG0:0x9D000000). To set up a partition for the User mode program, initialize BMXPUPBA as follows:

- $BMXPUPBA = BMXPFMSZ - USER_FLASH_PGM_SZ$

The USER_FLASH_PGM_SZ is the partition size of the User mode program. BMXPFMSZ is the bus matrix register that holds the total size of program Flash memory.

Example:

- Assuming the PIC32 device has 512 Kbytes of Flash memory, the BMXPFMSZ will contain 0x00080000.
- To create a user Flash program partition of 20 Kbytes (0x5000): $BMXPUPBA = 0x80000 - 0x5000 = 0x7B000$

The size of the user Flash will be 20K and the size left for the kernel Flash will be 512 Kbytes – 20 Kbytes = 492 Kbytes.

The user Flash partition will extend from 0x7D07B000 to 0x7D07FFFF (virtual addresses).

The Kernel mode partition always starts from KSEG1:0xBD000000 or KSEG0:0x9D000000. In the above example, the kernel partition will extend from 0xBD000000 to 0xBD07AFFF (492 Kbytes in size).

Figure 3-3: Flash Partitioning

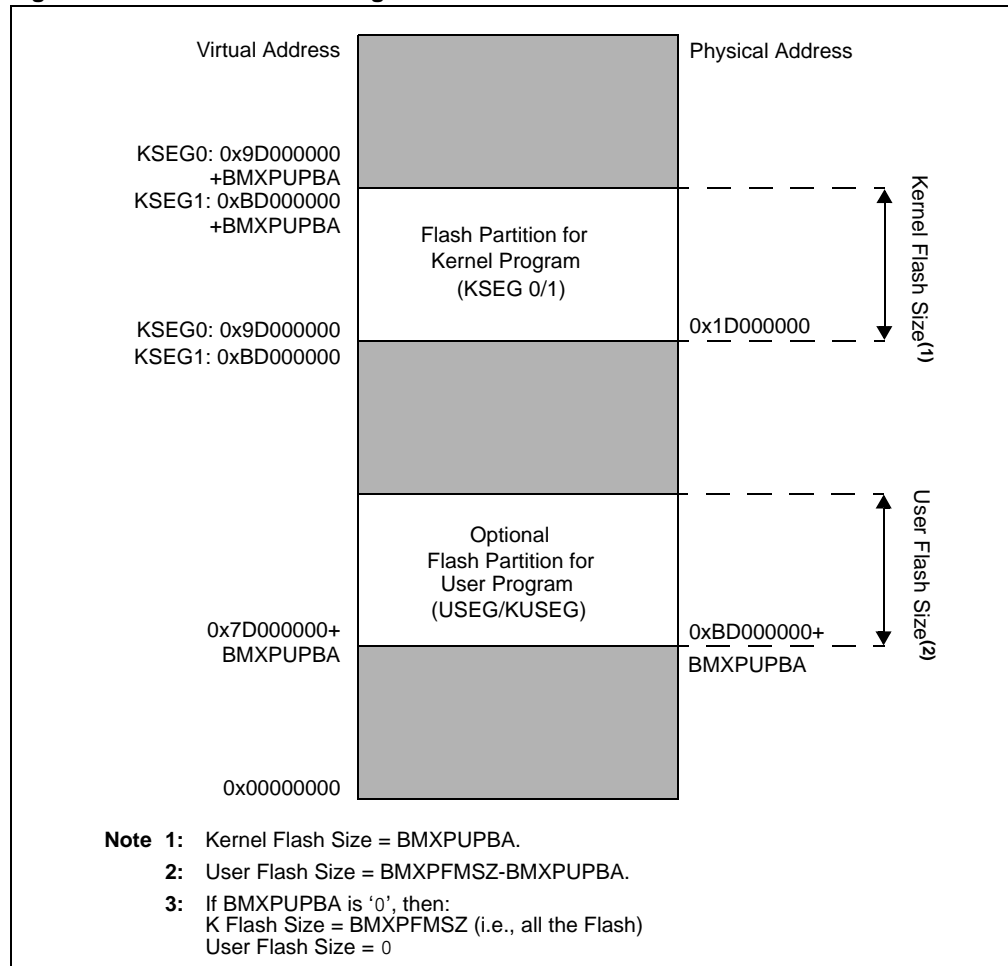

3.4.3 RAM Partitioning

The RAM memory can be divided into four partitions:

- Kernel Data
- Kernel Program
- User Data
- User Program

To execute from data RAM, a kernel or user program partition must be defined. At Power-on Reset (POR), the entire data RAM is assigned to the kernel data partition. This partition always starts from the base of the data RAM. See [Figure 3-4](#) for more information.

Note 1: To partition the RAM, you must program all of the following registers: BMXDKPBA, BMXDUDBA and BMXDUPBA.

2: The size of the available RAM is given by the BMXDRMSZ register.

Figure 3-4: RAM Partitioning

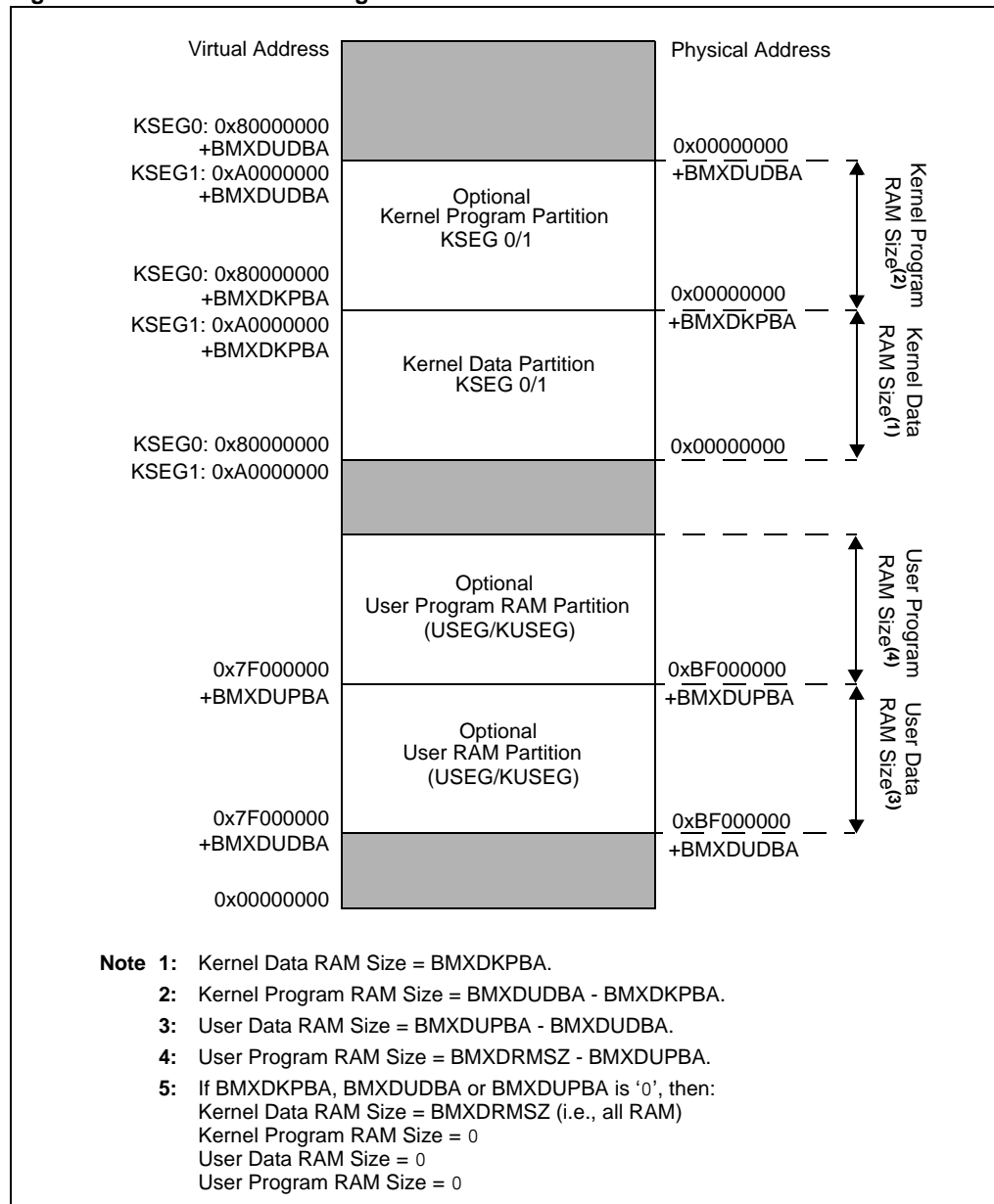

3.4.3.1 Kernel Data RAM Partition

The kernel data RAM partition is located at virtual address KSEG0:0x80000000, KSEG1:0xA0000000. It is always active and cannot be disabled.

If any of the BMXDKPBA, BMXDUDBA or BMXDUPBA registers is '0', the entire RAM is assigned to kernel data RAM (i.e., the size of the kernel data RAM partition is given by the BMXDRMSZ register value; see [Figure 3-5](#)). Otherwise, the size of the kernel data RAM partition is given by the value of the BMXDKPBA register (see [Figure 3-6](#)).

The kernel data RAM partition exists on Reset and takes up all the available RAM, as the BMXDKPBA, BMXDUDBA and BMXDUPBA registers default to zero at any Reset.

Figure 3-5: RAM Partitioning When BMXDKPBA, BMXDUDBA or BMXDUPBA = 0

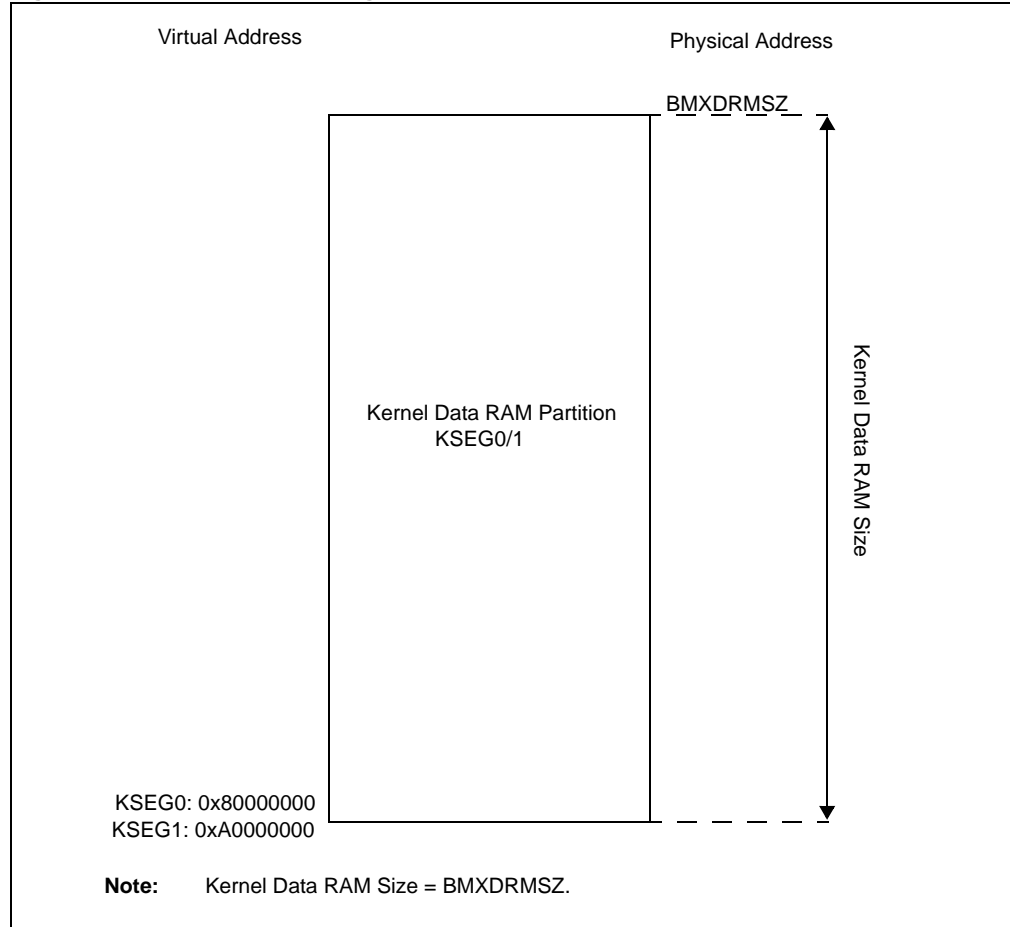
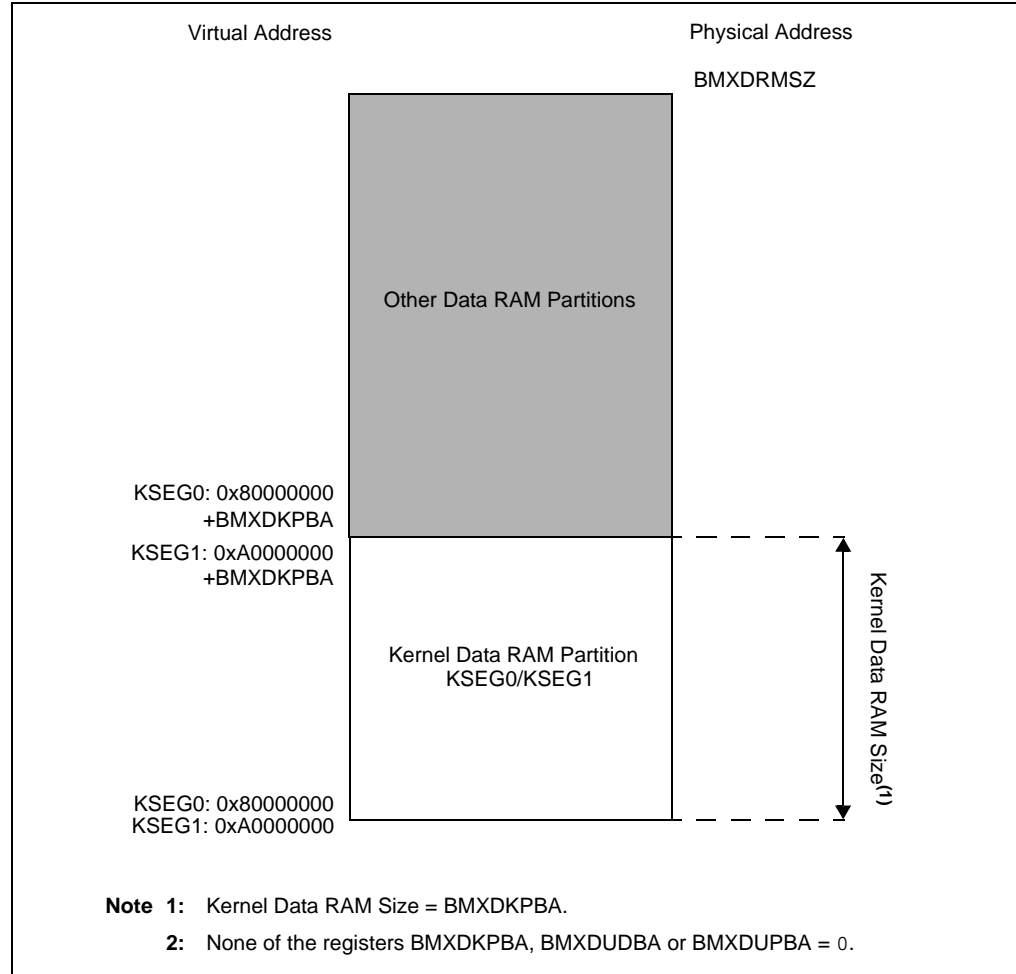

Figure 3-6: Kernel Data RAM Partitioning



3.4.3.2 Kernel Program RAM Partition

The kernel program RAM partition is required if code needs to be executed from data RAM in Kernel mode.

This partition starts at $KSEG0:0x80000000 + BMXDKPBA$ ($KSEG1:0xA0000000 + BMXDKPBA$), and its size is given by $BMXDUDBA - BMXDKPBA$ (see [Figure 3-7](#)).

The kernel program RAM partition does not exist on Reset, as the $BMXDKPBA$ and $BMXDUDBA$ registers default to zero at Reset.

Figure 3-7: Kernel Program RAM Partitioning

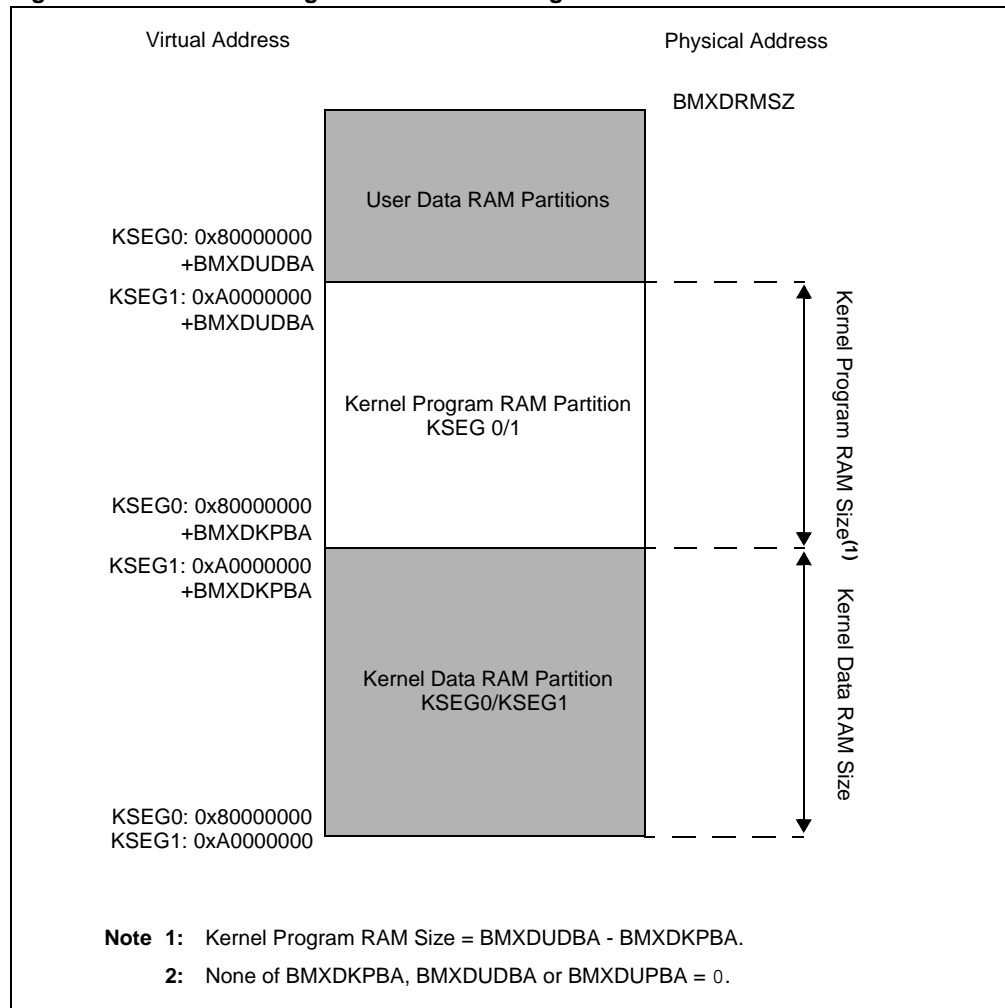

3.4.3.3 User Data RAM Partition

For User mode applications, a User mode data partition in RAM is required. This partition starts at address $0x7F000000 + \text{BMXDUDBA}$, and its size is given by $\text{BMXDUPBA} - \text{BMXDUDBA}$ (see Figure 3-8).

The user data RAM partition does not exist on Reset, as the BMXDUDBA and BMXDUPBA registers default to zero at Reset.

Figure 3-8: User Data RAM Partitioning

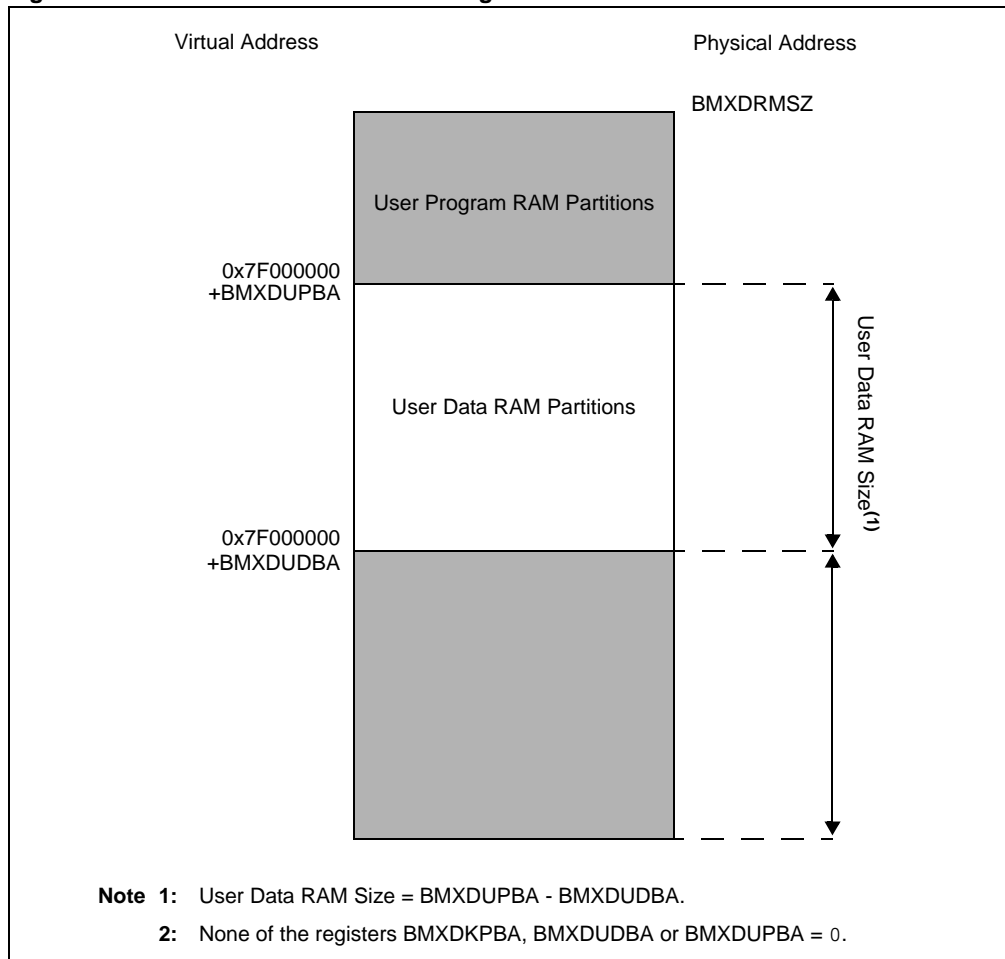

3.4.3.4 User Program RAM Partition

The user program partition in data RAM is required if code needs to be executed from data RAM in User mode. This partition starts at address $0x7F000000 + \text{BMXDUPBA}$, and its size is given by $\text{BMXDRMSZ} - \text{BMXDUPBA}$ (see [Figure 3-9](#)).

The User Program RAM partition does not exist on Reset, as the BMXDUPBA register defaults to zero at Reset.

Figure 3-9: User Program RAM Partitioning

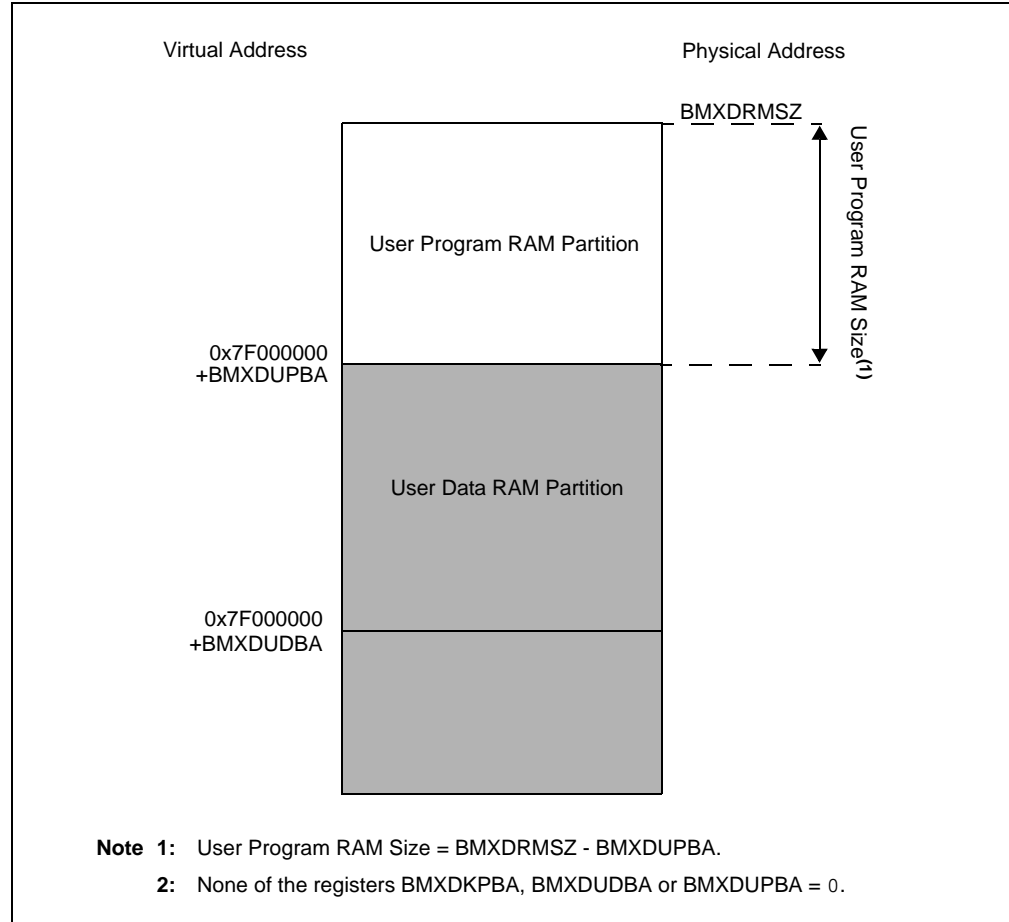

3.4.3.5 RAM Partitioning Examples

This section provides the following practical examples of RAM partitioning:

- RAM Partitioned as Kernel Data
- RAM Partitioned as Kernel Data and Kernel Program
- RAM Partitioned as Kernel Data and User Data
- RAM Partitioned as Kernel Data, Kernel Program and User Data
- RAM Partitioned as Kernel Data, Kernel Program, User Data and User Program

3.4.3.5.1 Example 1. RAM Partitioned as Kernel Data

The entire RAM is partitioned as kernel data RAM after a Reset. No other programming is required. Setting the BMXDKPBA, BMXDUDBA or BMXDUPBA register to '0' will partition the entire RAM space to a kernel data partition (see Figure 3-5).

3.4.3.5.2 Example 2. RAM Partitioned as Kernel Data and Kernel Program

For this example, assume that the available RAM on the PIC32 device is 32 KB, of which 8 KB kernel data RAM and 24 KB of kernel program RAM are needed. In this example, the user data RAM and user program RAM will have their sizes set to '0'.

A kernel data RAM partition is always required (see Figure 3-10 for more information).

The values of the registers are as follows:

- BMXDRMSZ = 0x00008000 (read-only value)
- BMXDKPBA = 0x00002000 (i.e., 8 KB kernel data)
- BMXDUDBA = 0x00008000 (i.e., 0x6000 kernel program)
- BMXDUPBA = 0x00008000 (i.e., user data size = 0, and user program size = 0)

Figure 3-10: RAM Partitioning for 8 KB Kernel Data and 16 KB Kernel Program

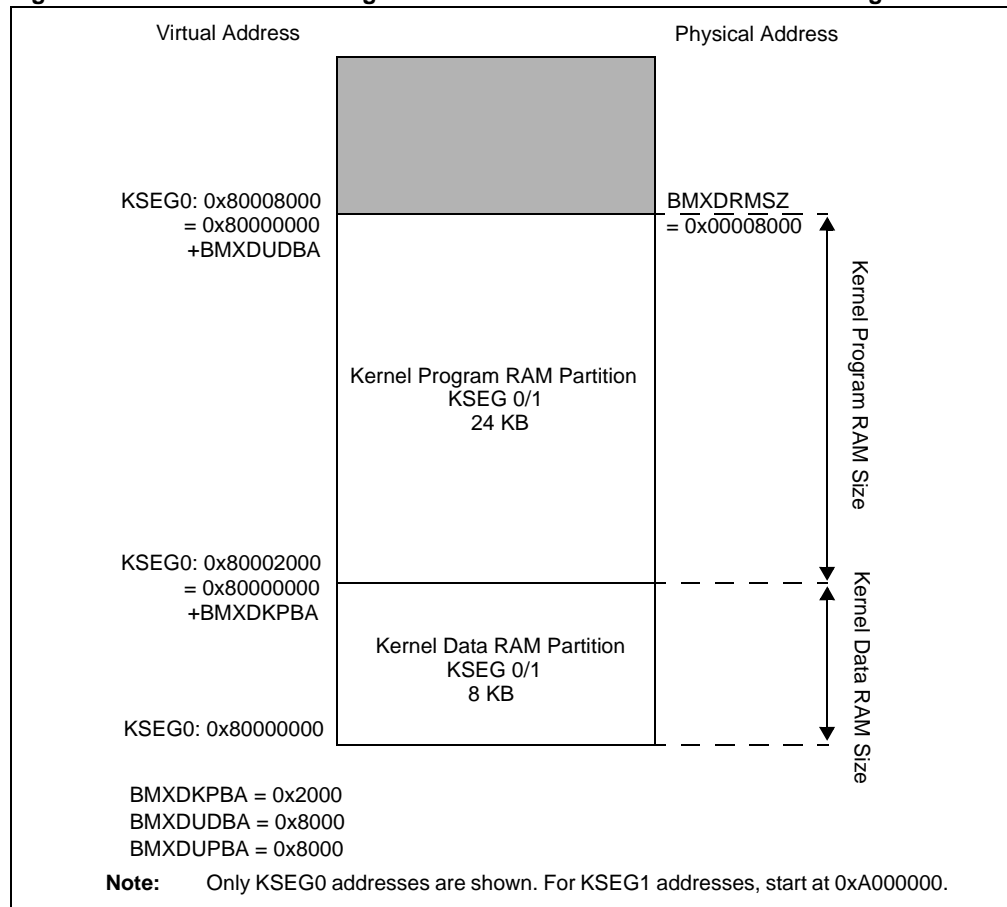

3.4.3.5.3 Example 3. RAM Partitioned as Kernel Data and User Data

For this example, assume that the available RAM on the PIC32 device is 32 KB, of which 16 KB of kernel data RAM and 16 KB of user data RAM are needed. In this example, the kernel program RAM and user program RAM will have their sizes set to '0'. See [Figure 3-11](#) for details.

The values of the registers are as follows:

- BMXDRMSZ = 0x00008000 (read-only value)
- BMXDKPBA = 0x00004000 (i.e., 16 KB kernel data)
- BMXDUDBA = 0x00004000 (i.e., 0 kernel program)
- BMXDUPBA = 0x00008000 (i.e., user data size = 16 KB, and user program size = 0)

Figure 3-11: RAM Partitioning for 16 KB Kernel Data and 16 KB User Data

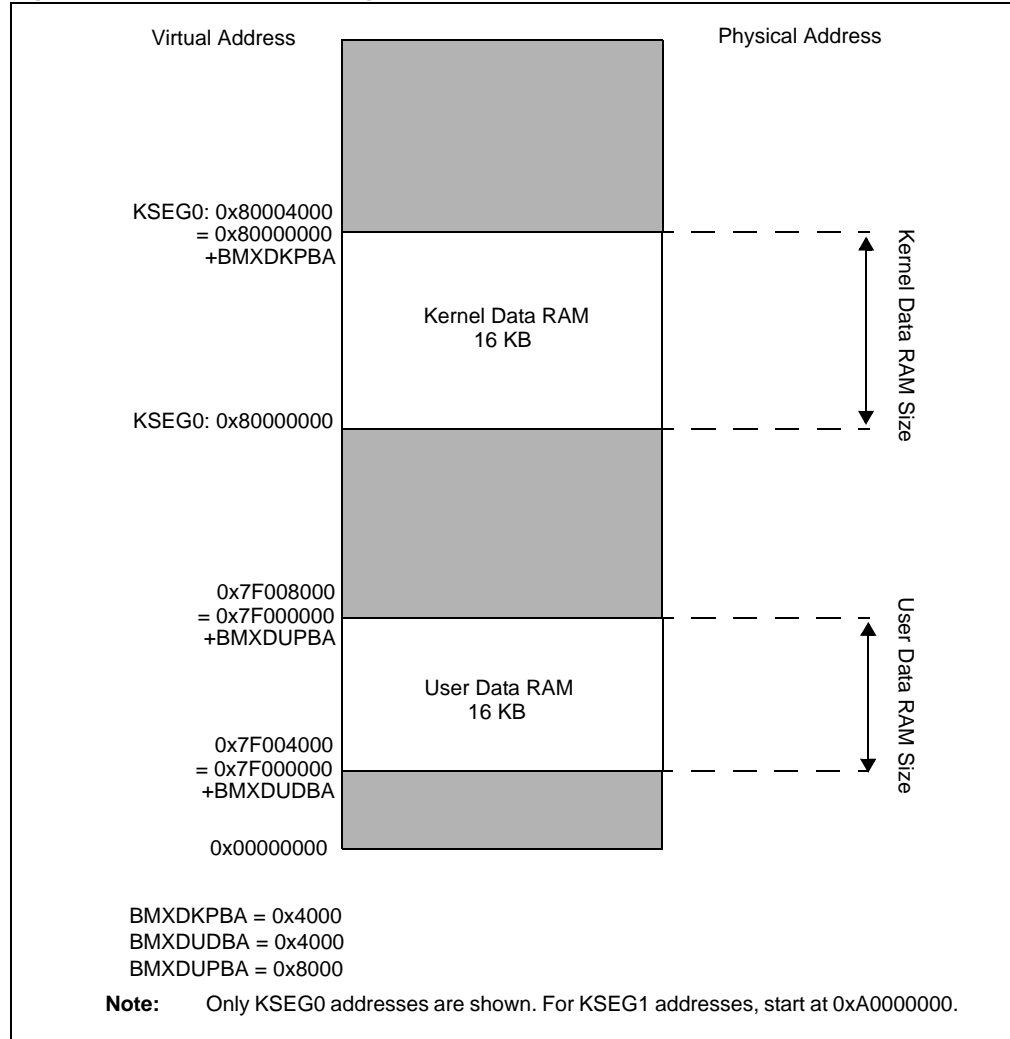

Section 3. Memory Organization

3.4.3.5.4 Example 4. RAM Partitioned as Kernel Data, Kernel Program and User Data

For this example, assume that the available RAM on the PIC32 device is 32 KB, and 4 KB of kernel data RAM, 6 KB of kernel program and 22 KB of user data RAM are needed. In this example, the user program RAM will have its size set to '0'. See Figure 3-12 for details.

The values of the registers are as follows:

- BMXDRMSZ = 0x00008000 (read-only value)
- BMXDKPBA = 0x00001000 (i.e., 4 KB kernel data)
- BMXDUDBA = 0x00002800 (i.e., 6 KB kernel program)
- BMXDUPBA = 0x00008000 (i.e., user data size = 22 KB, and user program size = 0)

Figure 3-12: RAM Partitioning for 4 KB K-Data, 6 KB K-Program and 22 KB U-Data

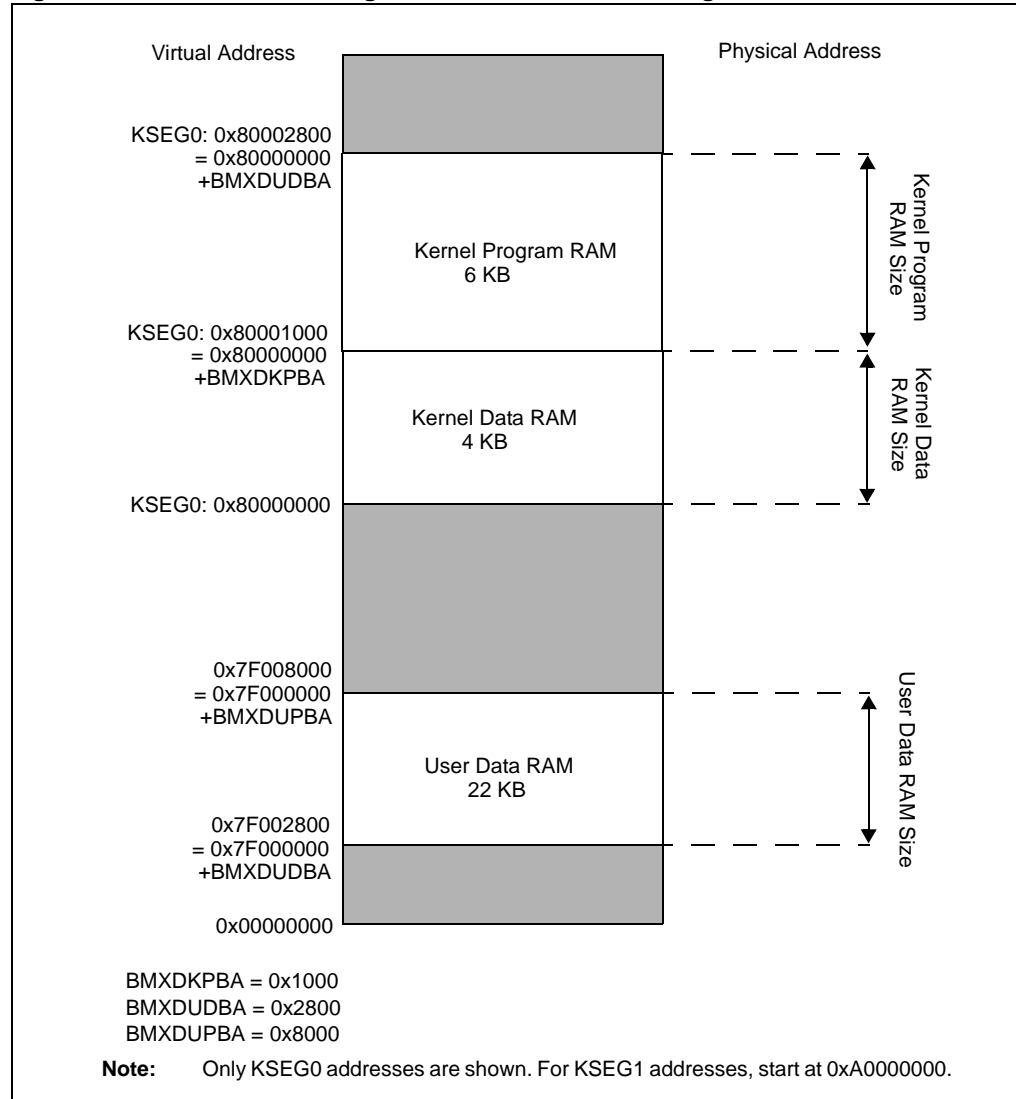

3.4.3.5.5 Example 5. RAM Partitioned as Kernel Data, Kernel Program, User Data and User Program

For this example, assume that the available RAM on the PIC32 device is 32 KB, and 6 KB of kernel data RAM, 5 KB of kernel program RAM, 12 KB of user data RAM and 9 KB of user program RAM are needed. See [Figure 3-13](#) for details.

The values of the registers are as follows:

- BMXDRMSZ = 0x00008000 (read-only value)
- BMXDKPBA = 0x00001800 (i.e., 6 KB kernel data)
- BMXDUDBA = 0x00002C00 (i.e., 5 KB kernel program)
- BMXDUPBA = 0x00005C00 (i.e., user data size = 12 KB, and user program size = 9 KB)

Figure 3-13: RAM Partitioning for 6 KB K-Data, 5 KB K-Program, 12 KB U-Data and 9 KB U-Program

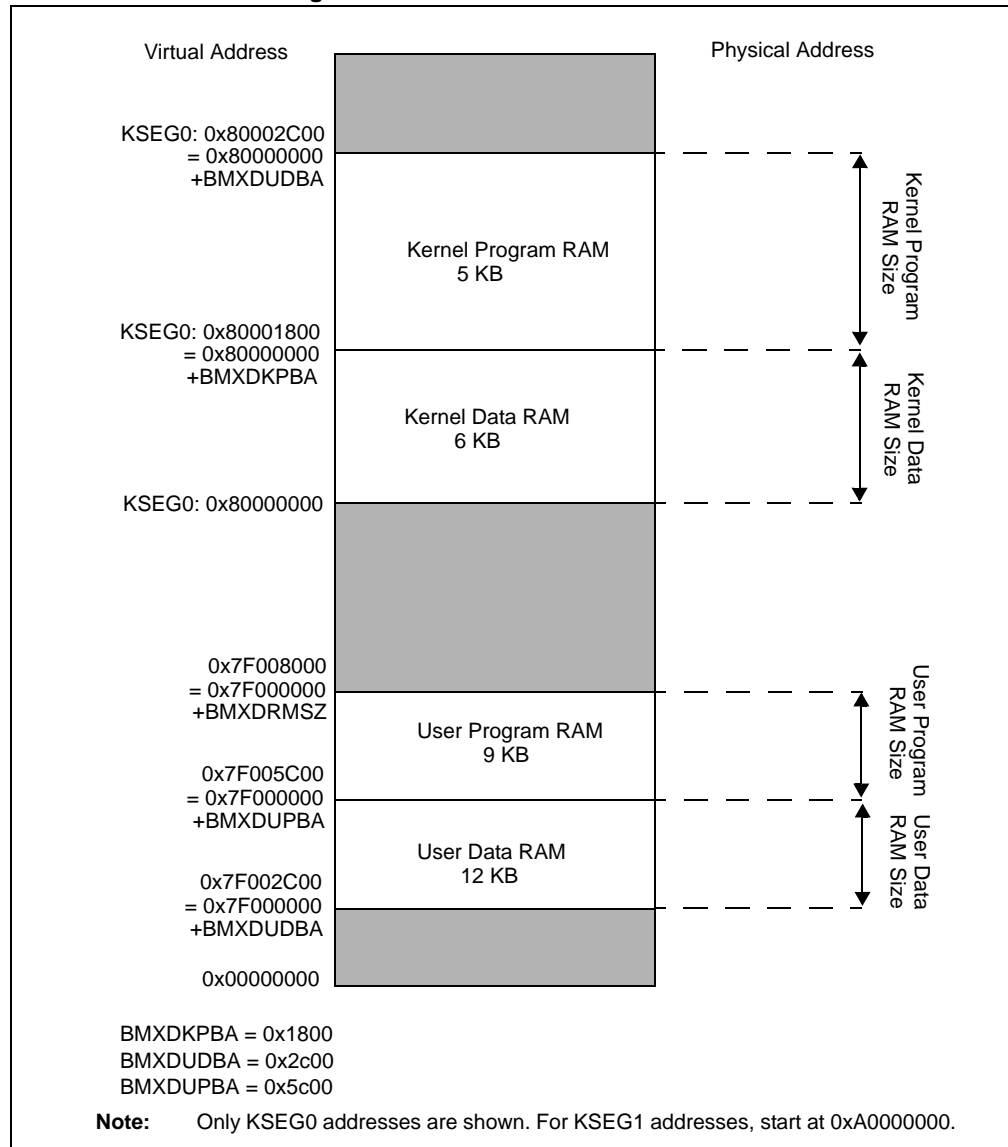

3.5 BUS MATRIX

The PIC32 processor supports two modes of operation: Kernel mode and User mode. The Bus Matrix controls the allocation of memory for each of these modes. It also controls the type of access, program or data, for a given region of address space.

The Bus Matrix connects master devices, generically called initiators, to slave devices, generically called targets. The PIC32 product family can have up to five initiators and three targets (e.g., Flash, RAM, etc.) on the main bus structure.

Of the five possible initiators, the CPU Instruction Bus (CPU IS), CPU Data Bus (CPU DS), In-Circuit Debug (ICD) and DMA Controller (DMA) are the default set of initiators and are always present. The PIC32 also includes an Initiator Expansion Interface (IXI) to support additional initiators for future expansion.

The Bus Matrix decodes a general range of addresses that map to a target. The target (memory or peripherals) may provide additional addresses depending on its functionality.

Table 3-3 lists the targets which the initiators can access.

Table 3-3: Initiator Access Map

Initiator	Target		
	Flash	RAM	Peripheral Bus
CPU IS	Y	Y	N
CPU DS	Y	Y	Y
DMA	Y	Y	Y
IXI	Y	Y	N
ICD	Y	Y	Y

Figure 3-14: Bus Matrix Initiators and Targets

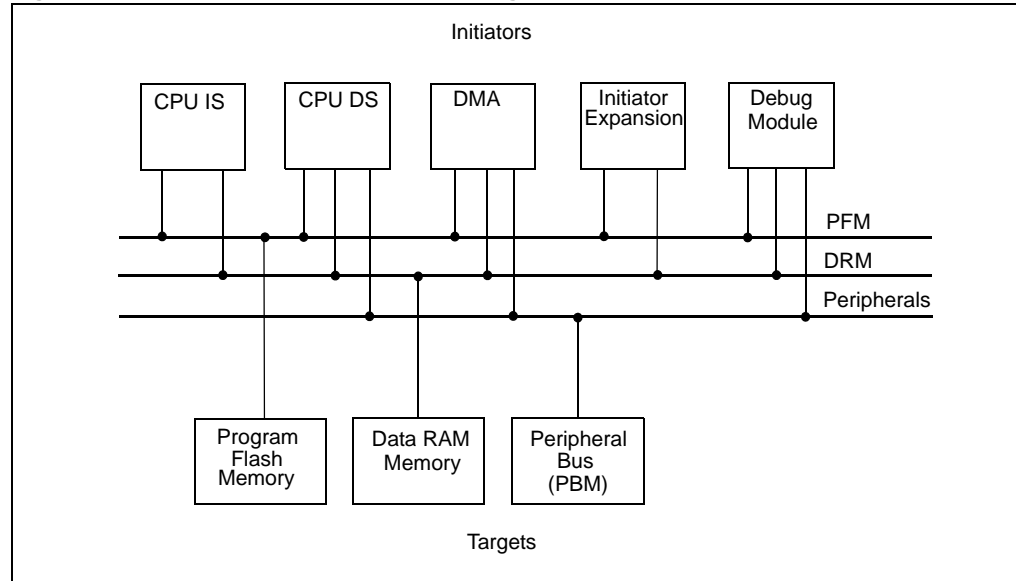

3.5.1 Initiator Arbitration Modes

Since there can be more than one initiator attempting to access the same target, an arbitration scheme must be used to control access to the target. The arbitration modes assign priority levels to all the initiators. The initiator with the higher priority level will always win target access over a lower priority initiator.

3.5.1.1 Arbitration Mode 0

The fixed priority scheme in Arbitration Mode 0 is illustrated in [Figure 3-15](#). The CPU data and instruction access are given higher priority than DMA access. Since this mode can starve the DMA, choose this mode when DMA is not being used.

As illustrated in [Figure 3-15](#), each initiator is assigned a fixed priority level. Programming the register field BMXARB (BMXCON<2:0>) to '0' selects Mode 0 operation.

Figure 3-15: Priority Assignment in Arbitration Mode 0

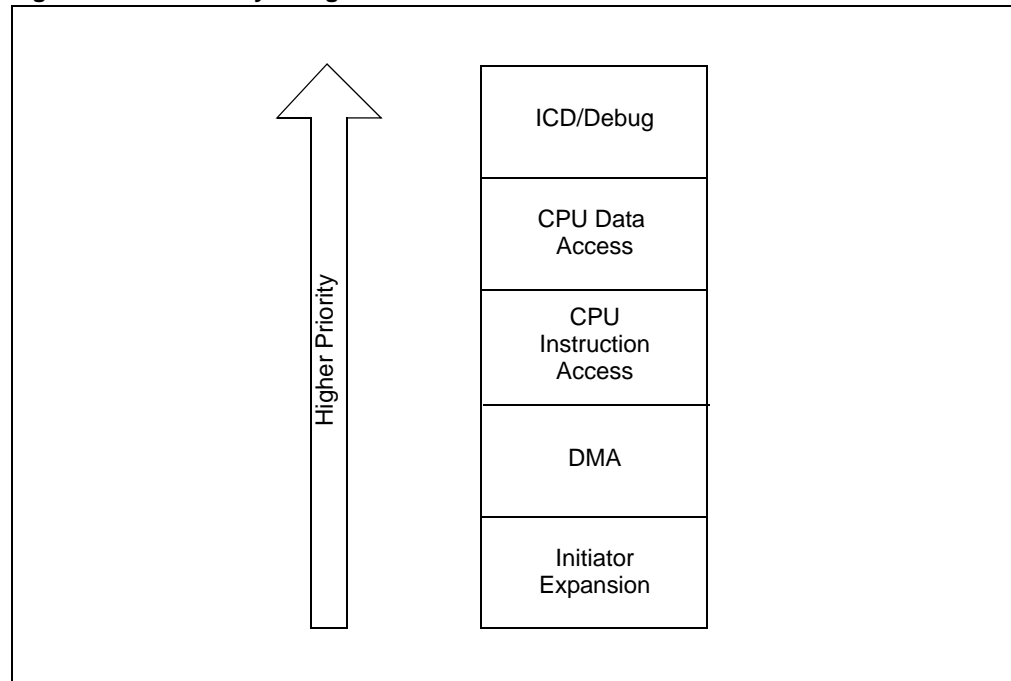

3.5.1.2 Arbitration Mode 1

Arbitration Mode 1 is a fixed priority scheme like Mode 0; however, the CPU IS is always the lowest priority. Figure 3-16 illustrates the priority scheme in Mode 1. Mode 1 arbitration is the default mode.

Programming the register field BMXARB (BMXCON<2:0>) to '1' selects Mode 1 operation.

Figure 3-16: Priority Assignment in Arbitration Mode 1

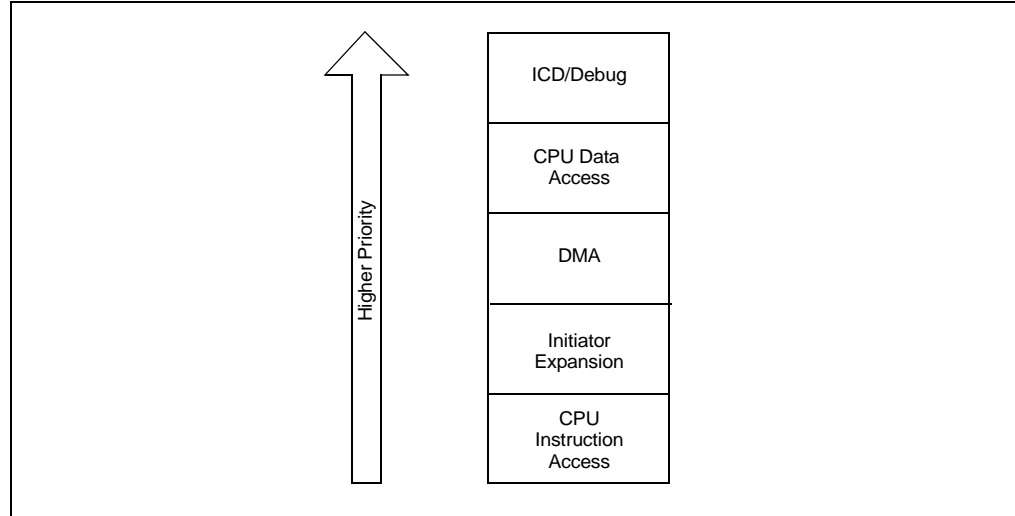

3.5.1.3 Arbitration Mode 2

Mode 2 arbitration supports rotating priority assignments to all initiators. Instead of a fixed priority assignment, each initiator is assigned the highest priority in a rotating fashion. In this mode, the rotating priority is applied with the following exceptions:

- CPU data is always selected over CPU instruction
- ICD is always the highest priority
- When the CPU is processing an exception (EXL = 1) or an error (ERL = 1), the arbiter temporarily reverts to Mode 0

Figure 3-17: Priority Assignments in Arbitration Mode 2

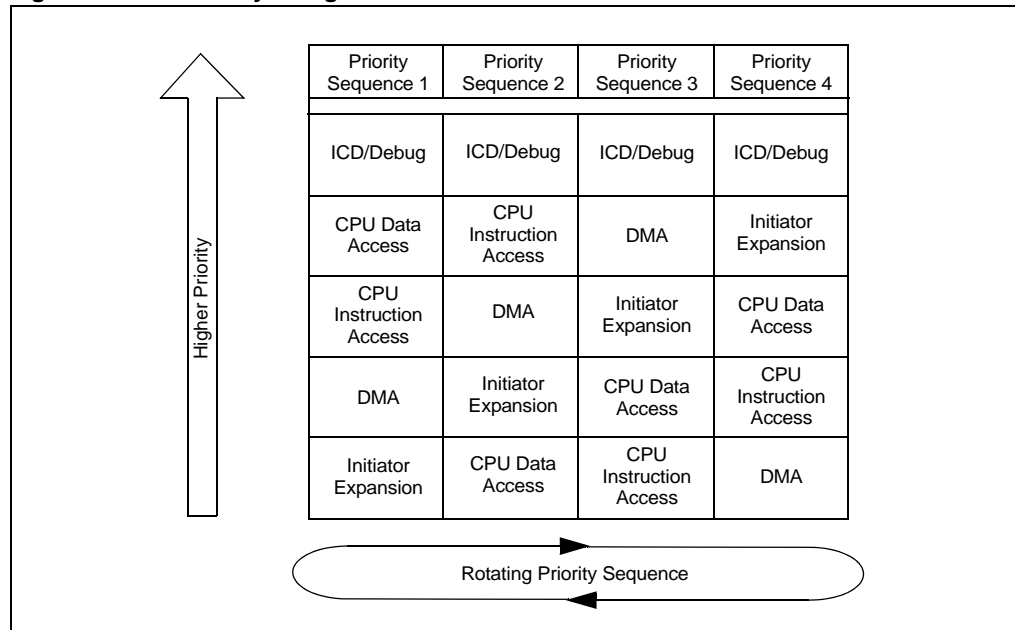

Note that priority sequence 2 is not selected in the rotating priority scheme if there is a pending CPU data access. In this case, once the data access is complete, sequence 2 is selected.

Each target's arbiter state machine keeps track of which initiator last controlled it and re-orders its priority separately from the other target arbiters. So if a target's priority sequence rotates with a data access pending, sequence 2 is skipped until the data access completes. This prevents an instruction access from taking priority over a data access for that target.

Programming the BMXARB bit (BMXCON<2:0>) to '010' selects Mode 2 operation.

3.5.2 Bus Error Exceptions

The Bus Matrix generates a bus error exception on:

- Any attempt to access unimplemented memory
- Any attempt to access an illegal target
- Any attempt to write to program Flash memory

Bus Error Exceptions may be temporarily disabled by clearing the BMXERRxxx bits in the BMXCON register, which is not recommended.

The Bus Matrix disables bus error exceptions for accesses from CPU IS and CPU DS while in Debug mode.

3.5.3 Break Exact Breakpoint Support

The PIC32 supports break exact breakpoints by inserting one Wait state to data RAM access. This method allows the CPU to stop execution before the breakpoint address instruction. This is useful for breakpointed store instructions. When the Wait state is not used, the break will still occur at the store instruction, however, the DRM location is updated with the store value. If the Wait state is enabled the DRM is not updated with the store value.

3.6 I/O PIN CONTROL

There are no I/O pins associated with this module.

3.7 OPERATION IN POWER-SAVING AND DEBUG MODES

3.7.1 Memory Operation on Power-up or Brown-out Reset (BOR):

- The contents of data RAM are undefined
- The BMX Base Address (BMXxxxBA) registers are reset to '0'
- The CPU is switched to Kernel mode

3.7.2 Memory Operation on Reset:

- The data RAM contents are retained. If the device is code-protected, the RAM contents are cleared
- The BMX base address registers (BMXxxxBA) are set to '0'
- The CPU is switched to Kernel mode

3.7.3 Memory Operation on Wake-up from Device Sleep or Idle Mode:

- The contents of data RAM are retained
- The contents of the BMX Base Address (BMXxxxBA) registers are not changed
- The CPU mode is unchanged

3.8 CODE EXAMPLES

Example 3-1: Create a User Mode Partition of 12K in Program Flash

```
BMXPUPBA = BMXPFMSZ - (12*1024); // User Mode Flash 12K,
// Kernel Mode Flash 500K (512K-12K)
```

Example 3-2: Create a Kernel Mode Data RAM Partition of 16K; Rest of RAM for Kernel Program

```
BMXDKPBA = 16*1024;
BMXDUDBA = BMXDRMSZ;
BMXDUPBA = BMXDRMSZ;
```

Example 3-3 can be used to create the following partitions in RAM:

- Kernel mode data = 12K
- Kernel mode program = 6K
- User mode data = 8K
- User mode program = 6K

Example 3-3: Create RAM Partitions

```
BMXDKPBA = 12*1024; // Kernel Data Partition of 12K.
// Start offset of Kernel Program Partition
BMXDUDBA = BMXDKPBA + (6*1024); // Kernel Program Partition of 6K
// Start offset of User Data Partition
BMXDUPBA = BMXDUDBA + (8*1024); // User Data Partition of 8K
// Start offset of User Program Partition.
// This partition will go up to the size of
// RAM (32K). So the partition size will be
// 6K (32K - 8K - 6K - 12K)
```

3.9 RELATED APPLICATION NOTES

This section lists application notes that are related to this section of the manual. These application notes may not be written specifically for the PIC32 device family, but the concepts are pertinent and could be used with modification and possible limitations. The current application notes related to the Memory Organization of the PIC32 family include the following:

Title	Application Note #
No related application notes at this time.	N/A

Note: Please visit the Microchip web site (www.microchip.com) for additional application notes and code examples for the PIC32 family of devices.

3.10 REVISION HISTORY

Revision A (August 2007)

This is the initial released version of this document.

Revision B (October 2007)

Updated document to remove Confidential status.

Revision C (April 2008)

Revised status to Preliminary.

Revision D (June 2008)

Minor formatting updates to register tables.

Revision E (July 2009)

This revision includes the following updates:

- Minor updates to the text and formatting have been incorporated throughout the document
- Added Notes 1, 2 and 3, which describe the Clear, Set and Invert registers to the following:
 - [Table 3-1](#): Memory Organization SFR Summary
 - [Register 3-1](#): BMXCON: Bus Matrix Configuration
 - [Register 3-2](#): BMXDKPBA: Data RAM Kernel Program Base Address
 - [Register 3-3](#): BMXDUDBA: Data RAM User Data Base Address
 - [Register 3-4](#): BMXDUPBA: Data RAM User Program Base Address
 - [Register 3-6](#): BMXPUPBA: Program Flash Memory User Program Base Address
- Removed all Clear, Set, and Invert register descriptions
- Added additional bit value definition (0x0001000) to [BMXDRMSZ: Data RAM Size Register](#) (see [Register 3-5](#))

Revision F (July 2010)

This revision includes the following updates:

- Minor updates to the text and formatting have been incorporated throughout the document
- Added Notes 4 and 5 to the following registers:
 - BMXDKPBA: Data RAM Kernel Program Base Address Register (see [Register 3-2](#))
 - BMXDUDBA: Data RAM User Data Base Address Register (see [Register 3-3](#))
 - BMXDUPBA: Data RAM User Program Base Address Register (see [Register 3-4](#))
 - BMXPUPBA: Program Flash (PFM) User Program Base Address Register (see [Register 3-6](#))
- Updated the PIC32 Address Map (see [Table 3-2](#))

Revision G (July 2012)

This revision includes the following updates:

- All references to PIC32MX were changed to: PIC32
- Updated the notes in the Memory Organization SFR Summary (see [Table 3-1](#))
- Removed the Clear, Set, and Invert register notes in all applicable register tables
- Updated the Virtual to Physical Fixed Memory Mapping Example (see [Figure 3-1](#))
- Updated the Boot Flash Memory (BFM) Size bits value definition (see [Register 3-8](#))
- Removed 3.9 “Design Tips”
- Minor updates to the text, as well as formatting changes have been incorporated throughout the document

Revision H (MAY 2015)

This revision includes the following updates:

- The following registers were updated:
 - BMXDKPBA: Data RAM Kernel Program Base Address Register (see [Register 3-2](#))
 - BMXDUDBA: Data RAM User Data Base Address Register (see [Register 3-3](#))
 - BMXDUPBA: Data RAM User Program Base Address Register (see [Register 3-4](#))
- **3.5.1.3 “Arbitration Mode 2”** was updated

Note the following details of the code protection feature on Microchip devices:

- Microchip products meet the specification contained in their particular Microchip Data Sheet.
- Microchip believes that its family of products is one of the most secure families of its kind on the market today, when used in the intended manner and under normal conditions.
- There are dishonest and possibly illegal methods used to breach the code protection feature. All of these methods, to our knowledge, require using the Microchip products in a manner outside the operating specifications contained in Microchip's Data Sheets. Most likely, the person doing so is engaged in theft of intellectual property.
- Microchip is willing to work with the customer who is concerned about the integrity of their code.
- Neither Microchip nor any other semiconductor manufacturer can guarantee the security of their code. Code protection does not mean that we are guaranteeing the product as “unbreakable.”

Code protection is constantly evolving. We at Microchip are committed to continuously improving the code protection features of our products. Attempts to break Microchip's code protection feature may be a violation of the Digital Millennium Copyright Act. If such acts allow unauthorized access to your software or other copyrighted work, you may have a right to sue for relief under that Act.

Information contained in this publication regarding device applications and the like is provided only for your convenience and may be superseded by updates. It is your responsibility to ensure that your application meets with your specifications. MICROCHIP MAKES NO REPRESENTATIONS OR WARRANTIES OF ANY KIND WHETHER EXPRESS OR IMPLIED, WRITTEN OR ORAL, STATUTORY OR OTHERWISE, RELATED TO THE INFORMATION, INCLUDING BUT NOT LIMITED TO ITS CONDITION, QUALITY, PERFORMANCE, MERCHANTABILITY OR FITNESS FOR PURPOSE. Microchip disclaims all liability arising from this information and its use. Use of Microchip devices in life support and/or safety applications is entirely at the buyer's risk, and the buyer agrees to defend, indemnify and hold harmless Microchip from any and all damages, claims, suits, or expenses resulting from such use. No licenses are conveyed, implicitly or otherwise, under any Microchip intellectual property rights.

Trademarks

The Microchip name and logo, the Microchip logo, dsPIC, FlashFlex, flexPWR, JukeBlox, KEELOQ, KEELOQ logo, Klear, LANCheck, MediaLB, MOST, MOST logo, MPLAB, OptoLyzer, PIC, PICSTART, PIC³² logo, RightTouch, SpyNIC, SST, SST Logo, SuperFlash and UNI/O are registered trademarks of Microchip Technology Incorporated in the U.S.A. and other countries.

The Embedded Control Solutions Company and mTouch are registered trademarks of Microchip Technology Incorporated in the U.S.A.

Analog-for-the-Digital Age, BodyCom, chipKIT, chipKIT logo, CodeGuard, dsPICDEM, dsPICDEM.net, ECAN, In-Circuit Serial Programming, ICSP, Inter-Chip Connectivity, KlearNet, KlearNet logo, MiWi, MPASM, MPF, MPLAB Certified logo, MPLIB, MPLINK, MultiTRAK, NetDetach, Omniscient Code Generation, PICDEM, PICDEM.net, PICkit, PICtail, RightTouch logo, REAL ICE, SQI, Serial Quad I/O, Total Endurance, TSHARC, USBCheck, VariSense, ViewSpan, WiperLock, Wireless DNA, and ZENA are trademarks of Microchip Technology Incorporated in the U.S.A. and other countries.

SQTP is a service mark of Microchip Technology Incorporated in the U.S.A.

Silicon Storage Technology is a registered trademark of Microchip Technology Inc. in other countries.

GestIC is a registered trademarks of Microchip Technology Germany II GmbH & Co. KG, a subsidiary of Microchip Technology Inc., in other countries.

All other trademarks mentioned herein are property of their respective companies.

© 2007-2015, Microchip Technology Incorporated, Printed in the U.S.A., All Rights Reserved.

ISBN: 978-1-63277-374-6

QUALITY MANAGEMENT SYSTEM
CERTIFIED BY DNV
== ISO/TS 16949 ==

Microchip received ISO/TS-16949:2009 certification for its worldwide headquarters, design and wafer fabrication facilities in Chandler and Tempe, Arizona; Gresham, Oregon and design centers in California and India. The Company's quality system processes and procedures are for its PIC[®] MCUs and dsPIC[®] DSCs, KEELOQ[®] code hopping devices, Serial EEPROMs, microperipherals, nonvolatile memory and analog products. In addition, Microchip's quality system for the design and manufacture of development systems is ISO 9001:2000 certified.



MICROCHIP

Worldwide Sales and Service

AMERICAS

Corporate Office
2355 West Chandler Blvd.
Chandler, AZ 85224-6199
Tel: 480-792-7200
Fax: 480-792-7277
Technical Support:
<http://www.microchip.com/support>
Web Address:
www.microchip.com

Atlanta
Duluth, GA
Tel: 678-957-9614
Fax: 678-957-1455

Austin, TX
Tel: 512-257-3370

Boston
Westborough, MA
Tel: 774-760-0087
Fax: 774-760-0088

Chicago
Itasca, IL
Tel: 630-285-0071
Fax: 630-285-0075

Cleveland
Independence, OH
Tel: 216-447-0464
Fax: 216-447-0643

Dallas
Addison, TX
Tel: 972-818-7423
Fax: 972-818-2924

Detroit
Novi, MI
Tel: 248-848-4000

Houston, TX
Tel: 281-894-5983

Indianapolis
Noblesville, IN
Tel: 317-773-8323
Fax: 317-773-5453

Los Angeles
Mission Viejo, CA
Tel: 949-462-9523
Fax: 949-462-9608

New York, NY
Tel: 631-435-6000

San Jose, CA
Tel: 408-735-9110

Canada - Toronto
Tel: 905-673-0699
Fax: 905-673-6509

ASIA/PACIFIC

Asia Pacific Office
Suites 3707-14, 37th Floor
Tower 6, The Gateway
Harbour City, Kowloon
Hong Kong
Tel: 852-2943-5100
Fax: 852-2401-3431

Australia - Sydney
Tel: 61-2-9868-6733
Fax: 61-2-9868-6755

China - Beijing
Tel: 86-10-8569-7000
Fax: 86-10-8528-2104

China - Chengdu
Tel: 86-28-8665-5511
Fax: 86-28-8665-7889

China - Chongqing
Tel: 86-23-8980-9588
Fax: 86-23-8980-9500

China - Dongguan
Tel: 86-769-8702-9880

China - Hangzhou
Tel: 86-571-8792-8115
Fax: 86-571-8792-8116

China - Hong Kong SAR
Tel: 852-2943-5100
Fax: 852-2401-3431

China - Nanjing
Tel: 86-25-8473-2460
Fax: 86-25-8473-2470

China - Qingdao
Tel: 86-532-8502-7355
Fax: 86-532-8502-7205

China - Shanghai
Tel: 86-21-5407-5533
Fax: 86-21-5407-5066

China - Shenyang
Tel: 86-24-2334-2829
Fax: 86-24-2334-2393

China - Shenzhen
Tel: 86-755-8864-2200
Fax: 86-755-8203-1760

China - Wuhan
Tel: 86-27-5980-5300
Fax: 86-27-5980-5118

China - Xian
Tel: 86-29-8833-7252
Fax: 86-29-8833-7256

ASIA/PACIFIC

China - Xiamen
Tel: 86-592-2388138
Fax: 86-592-2388130

China - Zhuhai
Tel: 86-756-3210040
Fax: 86-756-3210049

India - Bangalore
Tel: 91-80-3090-4444
Fax: 91-80-3090-4123

India - New Delhi
Tel: 91-11-4160-8631
Fax: 91-11-4160-8632

India - Pune
Tel: 91-20-3019-1500

Japan - Osaka
Tel: 81-6-6152-7160
Fax: 81-6-6152-9310

Japan - Tokyo
Tel: 81-3-6880-3770
Fax: 81-3-6880-3771

Korea - Daegu
Tel: 82-53-744-4301
Fax: 82-53-744-4302

Korea - Seoul
Tel: 82-2-554-7200
Fax: 82-2-558-5932 or
82-2-558-5934

Malaysia - Kuala Lumpur
Tel: 60-3-6201-9857
Fax: 60-3-6201-9859

Malaysia - Penang
Tel: 60-4-227-8870
Fax: 60-4-227-4068

Philippines - Manila
Tel: 63-2-634-9065
Fax: 63-2-634-9069

Singapore
Tel: 65-6334-8870
Fax: 65-6334-8850

Taiwan - Hsin Chu
Tel: 886-3-5778-366
Fax: 886-3-5770-955

Taiwan - Kaohsiung
Tel: 886-7-213-7828

Taiwan - Taipei
Tel: 886-2-2508-8600
Fax: 886-2-2508-0102

Thailand - Bangkok
Tel: 66-2-694-1351
Fax: 66-2-694-1350

EUROPE

Austria - Wels
Tel: 43-7242-2244-39
Fax: 43-7242-2244-393

Denmark - Copenhagen
Tel: 45-4450-2828
Fax: 45-4485-2829

France - Paris
Tel: 33-1-69-53-63-20
Fax: 33-1-69-30-90-79

Germany - Dusseldorf
Tel: 49-2129-3766400

Germany - Munich
Tel: 49-89-627-144-0
Fax: 49-89-627-144-44

Germany - Pforzheim
Tel: 49-7231-424750

Italy - Milan
Tel: 39-0331-742611
Fax: 39-0331-466781

Italy - Venice
Tel: 39-049-7625286

Netherlands - Drunen
Tel: 31-416-690399
Fax: 31-416-690340

Poland - Warsaw
Tel: 48-22-3325737

Spain - Madrid
Tel: 34-91-708-08-90
Fax: 34-91-708-08-91

Sweden - Stockholm
Tel: 46-8-5090-4654

UK - Wokingham
Tel: 44-118-921-5800
Fax: 44-118-921-5820

01/27/15